

MANUAL  
USER'S

**Instructions and warnings** **IE**  
Installer and Maintenance  
technician

 **IMMERGAS**

## UE AUDAX PRO V2

**Outdoor Condensing Unit**

Single-phase:

- UE AUDAX PRO 12 V2
- UE AUDAX PRO 14 V2
- UE AUDAX PRO 16 V2

Three-phase:

- UE AUDAX PRO 12 V2 T
- UE AUDAX PRO 14 V2 T
- UE AUDAX PRO 16 V2 T

\*1.045674ENG\*



## INDEX

Dear Customer,.....	3	8	Installation of chiller lines. ....	29	
General warnings .....	4	8.1	Geometric limits of the Chiller lines and Examples of installation. ....	29	
Safety symbols used.....	6	8.2	Selection of refrigerant pipe. ....	30	
Personal protective equipment. ....	6	8.3	Keep the refrigerant pipe clean and dry.....	30	
1	Product specifications. ....	7	8.4	Cutting and flaring of pipes.....	30
1.1	Product range. ....	7	8.5	Choose the insulation of the refrigerant pipe. ....	32
1.2	Accessories.....	7	8.6	Insulating the refrigerant pipe. ....	32
2	Outdoor unit specifications.....	8	8.7	Pipe welding. ....	33
3	Main components.....	9	8.8	Pressure test and search for leaks. ....	34
4	Installation of the unit.....	10	8.9	Vacuuming and dehydration of the pipes and the indoor unit.....	35
4.1	Outdoor unit installation position. ....	10	8.10	Refilling the refrigerant charge. ....	37
4.2	Installation guide near the sea. ....	10	8.11	Refilling the refrigerant charge. ....	37
4.3	Handling by means of ropes.....	11	8.12	Adding refrigerant. ....	38
4.4	Required spaces.....	12	8.13	Closing the valve stem.....	40
4.5	Installing the outdoor unit. ....	14	8.14	Opening the valve stem.....	40
4.6	Mount of outdoor unit. ....	14	9	Cooling cycle diagrams.....	41
4.7	Drainage of the outdoor unit. ....	15	9.1	Diagram. ....	41
4.8	Positioning the unit in a rigid climate.....	16	10	Wiring diagram.....	42
5	Electrical connections.....	17	10.1	Single-phase wiring diagram.....	42
5.1	General configuration of the system. ....	17	10.2	Three-phase wiring diagram. ....	43
6	Connection of the cable.....	19	11	Microswitch and key function settings.....	44
6.1	Power cable specifications. ....	19	11.1	Testing operations.....	44
6.2	Specifications of the connection cables (commonly used). ....	20	12	“Pump down” execution. ....	47
6.3	Specifications of single-phase terminal block.....	20	12.1	Purpose of “Pump down”.....	47
6.4	Specifications of three-phase terminal block.....	20	12.2	Important warnings for “Pump down” execution.....	47
6.5	Power cable connection diagram.....	21	12.3	Pouring the refrigerant into an external cylinder before carrying out the pump down .....	48
6.6	Connection of power terminal block.....	25	13	Completion of installation.....	49
6.7	Earthing. ....	25	14	Final inspections and test operation. ....	50
6.8	How to connect extension cables.....	26	14.1	Final inspections and test operation .....	50
7	Checking correct earthing.....	28	14.2	Test operation.....	50

## ***Dear Customer,***

*Congratulations for having chosen a top-quality Immergas product, able to assure well-being and safety for a long period of time. As an Immergas Customer, you can also count on a qualified After-sales service, prepared and updated to guarantee constant efficiency of your heat pump. Read the following pages carefully: you will be able to draw useful tips on the proper use of the device, compliance with which will confirm your satisfaction with the Immergas product.*

*For assistance and routine maintenance, contact Authorised Service Centres: they have original spare parts and are specifically trained directly by the manufacturer.*

The company **IMMERGAS S.p.A.**, with registered office in via Cisa Ligure 95 42041 Brescello (RE), declares that the design, manufacturing and after-sales assistance processes comply with the requirements of standard **UNI EN ISO 9001:2015**.

For further details on the product CE marking, request a copy of the Declaration of Conformity from the manufacturer, specifying the appliance model and the language of the country.

The manufacturer declines all liability due to printing or transcription errors, reserving the right to make any modifications to its technical and commercial documents without forewarning.



### ***Correct disposal of the product***

***(Waste electrical and electronic equipment)(Applicable in Countries with separate waste collection systems)***

When this symbol is applied on the product, on the accessories or on its documentation, it means that the product and relative electronic accessories must not be disposed of with other waste at the end of its life cycle. To avoid damaging the environment or health due to incorrect waste disposal, the user is recommended to separate the product and the above-mentioned accessories from other types of waste and to recycle them responsibly by sending them to authorised facilities in compliance with local standards.

Household users, as an alternative to the autonomous management referred to above, can deliver the equipment they wish to dispose of to the retailer when purchasing a new equivalent type of equipment. It is possible to deliver free of charge the electronic products with dimensions of less than 25 cm that have to be disposed to retailers of electronic products with a sales area of at least 400 m<sup>2</sup>.

Corporate users (companies and professionals) should contact their supplier and verify the terms and conditions of the purchase contract. This product and relative electronic accessories must not be disposed of together with other commercial waste.

## GENERAL WARNINGS

- Carefully follow the precautions listed below as they are crucial to guarantee the safety of the product.

### ATTENTION:



- Before carrying out service operations or accessing the internal components of this Outdoor Condensing Unit, it is essential to disconnect the power supply.
- Make sure that installation and performance tests are carried out by qualified personnel.
- Observance of all the precautions, warnings and indications given in this manual are essential to prevent serious damage to the system and injuries to people.

- Carefully read the content of this manual before installing the device and keep it in a safe place so that it can be easily available for consultation by the user.
- For greater safety, the installer should always read everything contained in this manual with the utmost attention.
- Store the use and maintenance manual in a safe place and remember to hand it over to the new owner should the device be sold or transferred.
- This manual explains how to install the condensing unit. The use of indoor units equipped with different and therefore incompatible control systems as well as being able to cause damage to the appliance causes the immediate invalidation of the manufacturer's warranty. The manufacturer will not be held liable for damage resulting from the use of the appliance with units not compatible with it.
- The manufacturer declines all responsibility for any damage due to modifications not previously authorized by itself in writing and/or errors in the electrical and/or hydraulic and/or refrigerator connection of the appliance. Failure to comply with these instructions or with the requirements set forth in the "Operating limits" table, including those in the manual, immediately invalidates the warranty.
- Failure to comply with the instructions indicated in the production specifications immediately invalidates the warranty.
- Do not use the device if you notice any damage on it or if you perceive something strange, such as a loud noise or burnt smell.
- To prevent electrocution, fire or injury, always switch off the unit, disable the protective switch and, if smoke escapes, if the unit is extremely noisy or the power cable is overheated, contact the Authorised Technical Service Centre.
- The appliance as well as the electrical connections, the refrigeration lines and the protective devices must be inspected at regular intervals. All inspections must be performed only by qualified personnel.
- The unit contains moving and electric parts which must always be kept out of the reach of children.
- Do not have unauthorised personnel attempt to repair, move, modify or reinstall the unit. These operations could cause damage to the product, electric shocks and fire.
- Do not place liquid containers or other objects on the unit.
- All the materials used to manufacture and package the condensing unit are recyclable.
- The packaging material and the dead batteries of the remote control (optional) must be disposed of in compliance with local standards.
- The refrigerant in the condensing unit must be disposed of as special waste. At the end of its life, the device must be disposed in a collection facility or returned to the shop so that it can be disposed of correctly and safely.
- Wear protective gloves to unpack, move, install and repair the unit to avoid getting injured by the edges of the appliance.
- Do not touch the internal parts (water pipes, refrigerant pipes, heat exchanger, etc.) while the unit is operating. If an internal part needs to be adjusted, stop the unit, leave it as long as necessary to cool off and make sure to put on protective gloves.
- In case of refrigerant leaks, try not to come into contact with the refrigerant as this could cause serious injury.
- If the appliance is installed in a closed room, consider adequate ventilation to avoid a leak level beyond the maximum allowed limit.
- In that case, there is the risk of death by suffocation.
- Make sure to dispose of the packaging materials quickly and safely. Otherwise the nails, the plastic and the timber of which it is made could represent a serious danger of injury for the children.
- The device must be inspected upon receipt. If you notice any damage, DO NOT INSTALL THE PRODUCT and immediately report any damage to the carrier or dealer (the purchase may have been made from a wholesaler or a sales agent).

- To ensure the possibility of carrying out any maintenance or repair operations around the appliance, our units must be installed according to the clearance spaces. If the units are installed without complying with the procedures described, all the additional costs that may arise from the use of shafts, scaffolding, stairs, etc. that are necessary to access the appliance (in SAFETY CONDITIONS, as prescribed by the current Accident Prevention Regulations) will be CHARGED to the customer also for the interventions performed during the warranty period.
- Always make sure that the power supply complies with local safety standards.
- Check that the supply voltage and frequency comply with the specifications and that there is sufficient input power to guarantee operation of any other household appliance connected to the same power lines. Always make sure that the on-off switches and circuit breakers are adequately sized.
- Always check that the electrical connections (arrangement and section of cables, cable lugs, protection devices, etc.) comply with the electrical specifications and with the instructions in the wiring diagram. Always check that all of the connections comply with the regulations applicable to installation of the air/water heat pumps. All devices connected to the power supply line must be able to disconnect automatically in the presence of overvoltage.
- The ground connection must not be made on the cables of telephone lines, gas pipes, pipes where water can flow, lightning protection systems or for the absorption of peaks. Otherwise, or if made incorrectly, the earth connection could cause electric shock or fire.
- Install both a differential switch (circuit breaker) and a magnetothermic switch sized as prescribed by the local regulations in force.
- Failure to do so, would result in the risk of electrocution and fire.
- Make sure that condensate exits properly from the unit even in case of low outside temperature. Both the drain pipe and the coolant/air exchanger heater must be made in such a way that the condensate contained in them cannot freeze and clog them. If the drain is not done properly for release of condensate, the unit could be damaged by ice blocks and the system could be stopped.
- Install the power cable and the communication cable with the indoor unit at least one meter from each electrical equipment.
- Protect the appliance against mice or other rodents. They could gnaw on cables and other electrical components causing malfunction, development of fumes and fire. Inform the customer to keep the area around the unit clean.
- The electric heater must not be disassembled or altered by the user or installer.
- This appliance is not intended to be used by persons (including children) with reduced physical, sensory or mental capabilities or lacking experience and the necessary knowledge, unless they are supervised or trained on use of the appliance by someone in charge of their safety. Children must be supervised to make sure they do not play with the appliance.
- For use in Europe: this appliance may be used by children at least 8 years old or by persons with reduced physical, sensory or mental capabilities or lacking experience and basic notions, as long as they are supervised or properly trained on safe use of the appliance and are aware of the risks posed by it. Children must be supervised to make sure they do not play with the appliance. The appliance must not be cleaned and serviced by children without the supervision of an adult.
- Make sure not to modify the power cable, to make extensions or connections with several wires.
- Poor quality connections or insulation, or exceeding the current limit, could cause shock and fire.
- If extensions need to be made due to damage along the power line, refer to the chapter “How to connect extension power cables” in the installation manual.

## SAFETY SYMBOLS USED.



### GENERIC HAZARD

Strictly follow all of the indications next to the pictogram. Failure to follow the indications can generate hazard situations resulting in possible harm to the health of the operator and user in general.



### ELECTRICAL HAZARD

Strictly follow all of the indications next to the pictogram. The symbol indicates the appliance's electrical components or, in this manual, identifies actions that can cause an electrical hazard



### WARNING FOR INSTALLER

Read the instruction booklet carefully before installing the product.



### NOTE FOR INSTALLER

Indicates useful tips or additional information for the installer.



### WARNING FOR USER

Read the instruction booklet carefully before using the product.



### READ AND UNDERSTAND THE INSTRUCTIONS

Read and understand the appliance's instructions before performing any operation, carefully following the indications provided.



### INFORMATION

Indicates useful tips or additional information in general.



**The user must not dispose of the appliance at the end of its service life as municipal waste, but send it to appropriate collection centres.**

## PERSONAL PROTECTIVE EQUIPMENT.



### SAFETY GLOVES



### SAFETY GOGGLES



### SAFETY FOOTWEAR

# 1 PRODUCT SPECIFICATIONS.

## 1.1 PRODUCT RANGE.

The products described in this booklet are:

### Single-phase version

- UE AUDAX PRO 12 V2
- UE AUDAX PRO 14 V2
- UE AUDAX PRO 16 V2

### Three-phase version

- UE AUDAX PRO 12 V2 T
- UE AUDAX PRO 14 V2 T
- UE AUDAX PRO 16 V2 T

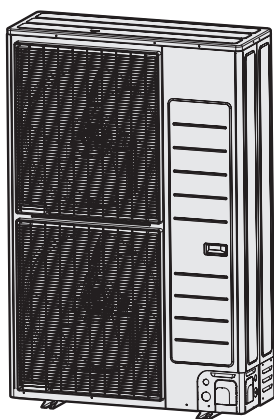



1

## 1.2 ACCESSORIES.

Keep the supplied accessories at hand until installation is complete. Deliver the installation manual to the customer at the end of the installation. The amounts are indicated in brackets.

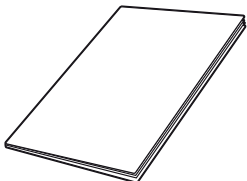
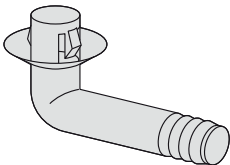
The condensing outdoor unit of the basic indoor heat pump works depending on the outdoor climate.

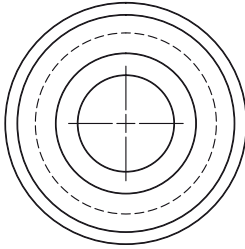
Installation manual (1)	Drain plug (2)	Rubber feet (4)	Drain plug (3)
			

## 2 OUTDOOR UNIT SPECIFICATIONS.

Model (Single-phase)	Unit	UE AUDAX PRO 12 V2	UE AUDAX PRO 14 V2	UE AUDAX PRO 16 V2
Power supply	-	1P, 220~240 CA, 50 Hz		
Weight (net / gross)	kg	100.0/109.5		
Net dimensions (LxHxP)	mm	940 x 1.420 x 330		
Sound pressure level (central heating / cooling)	dB(A)	50 / 50	50 / 52	52 / 54
Operating field (central heating / cooling)	°C	-25~35/10~46		

Model (Three-phase)	Unit	UE AUDAX PRO 12 V2 T	UE AUDAX PRO 14 V2 T	UE AUDAX PRO 16 V2 T
Power supply	-	3P, 380~415 CA, 50 Hz		
Weight (net / gross)	kg	101.5/111.0		
Net dimensions (LxHxP)	mm	940 x 1.420 x 330		
Sound pressure level (central heating / cooling)	dB(A)	50 / 50	50 / 52	52 / 54
Operating field (central heating / cooling)	°C	-25~35/10~46		

With external temperatures of -25 °C ~ -20 °C operation is possible but performance is not guaranteed.



# 3 MAIN COMPONENTS.

General dimensions in mm.

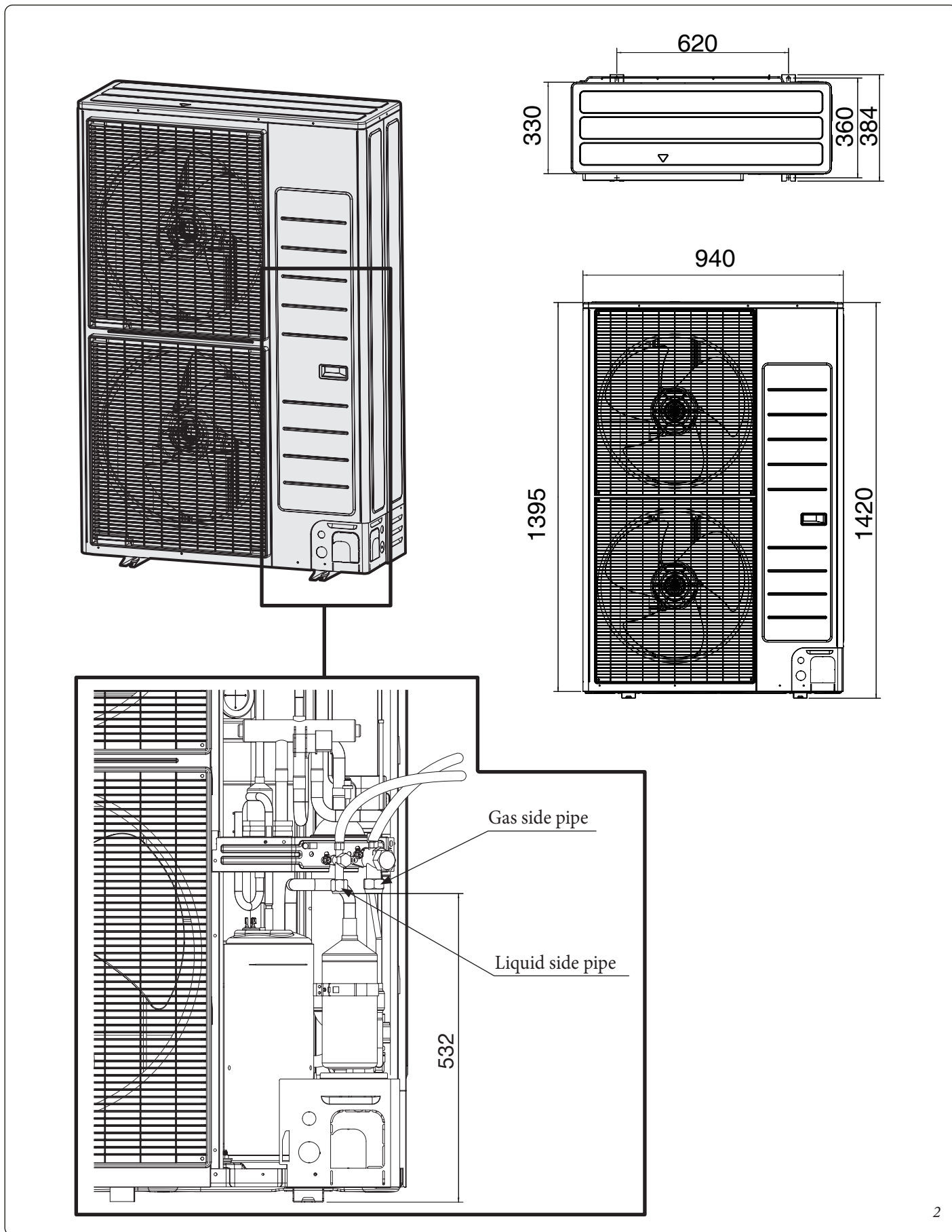

# 4 INSTALLATION OF THE UNIT.

## 4.1 OUTDOOR UNIT INSTALLATION POSITION.

The installation site must be chosen in agreement with the user and taking into account some further specifications.

- The outdoor unit must not be positioned on its side or upside down, as the lubricating oil of the compressor could enter the cooling circuit and seriously damage the unit.
- The chosen location must be dry and ventilated, but not directly exposed to sunlight and strong winds.
- The air must be able to circulate freely through the appliance.
- Choose a position where the noise of the condensing unit during operation or the discharge air do not disturb neighbours.
- The selected position should allow easy connection of both cables and pipes.
- The support surface must be flat, stable, sturdy at least enough to withstand the weight of the appliance and not such as to generate any useless noise and vibrations.
- Position the outdoor unit so that the air flow is directed outdoors.
- There must be no trees or animals nearby the appliance which could impair its operation.
- The device must be located at a sufficient distance from radio and/or stereo systems as well as from computers, etc.

## 4.2 INSTALLATION GUIDE NEAR THE SEA.

Make sure to follow these guidelines for installation along the sea coast.

1. Do not install the appliance where it is directly exposed to sea water or breeze.
  - Install the product behind a structure (like a building) which can block the sea breeze.
  - Even when it is inevitable to install the appliance along the seacoast, make sure it is not exposed directly to the sea breeze by installing a protective wall.
2. Consider that the saline particles which adhere to the external panels must be sufficiently washed.
3. Since residual water at the bottom of the outdoor unit significantly promotes corrosion, make sure the slope does not affect drainage.
  - Keep the floor level so that rain does not make any puddles.
  - Be careful not to obstruct the drain hole with foreign substances
4. When the appliance is installed on the beach, clean it regularly with water to remove any attached salinity.
5. Make sure to install the appliance where water can be drained conveniently. In particular, make sure that the part of the base drains well.
6. If the appliance is damaged during installation or maintenance, make sure to restore it.
7. Regularly check the condition of the product.
  - Check the installation site every 3 months and perform an anti-corrosion treatment with grease and water-repellent wax according to the conditions of the appliance.
  - Take appropriate measures to cover the product when it needs to be stopped for a long period of time, for example peak hours.
8. The product requires a special anti-corrosion treatment if installed within 500 m from the sea.

For further information, contact the Authorised Technical Assistance Centre.

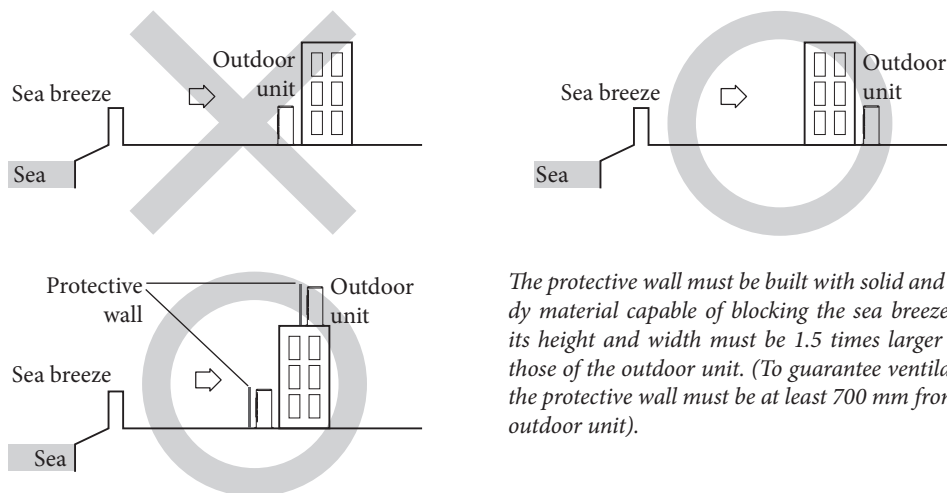

*The protective wall must be built with solid and sturdy material capable of blocking the sea breeze and its height and width must be 1.5 times larger than those of the outdoor unit. (To guarantee ventilation, the protective wall must be at least 700 mm from the outdoor unit).*

**ATTENTION:**

**Depending on the condition of the power system, unstable voltage or power supply may cause the components or control system to malfunction (in places that use electric generators, etc).**



Do not install the appliance in the following places.

- Places where there is mineral oil or arsenic acid. Otherwise, the plastic parts could corrode, damaging the appliance. The capacity of the heat exchanger could be reduced with serious impacts on the performance of the entire appliance.
- Places where corrosive gases are present, such as those exhaled by ventilation pipes or flues. Copper pipes would be corroded with subsequent refrigerant leaks.
- Places with the risk of leaks of combustible gases, carbon fibres or flammable dust. Places where thinners or petrol are handled.

**ATTENTION:**

**This device must be installed according to current electrical standards. We suggest not to install it overhanging but on the floor.**



- In case of overhanging installation, the appliance must be firmly anchored to the support structure.
- The water that drips from the drainage hose must always be able to do so without any obstacle.
- When the appliance is installed cantilevered, it must be at least 2 m from the floor or in such a way that the heat emitted by the unit does not come into direct contact with passers-by (Refer to standards in force relating to structures in the construction field).

**4.3 HANDLING BY MEANS OF ROPES.**

The appliance must be lifted by slinging it with two 8 m long ropes, as illustrated in figure 4. To avoid damages before lifting, it is advisable to place protective cloths between the ropes and the appliance.

Depending on the model, the appearance of the device may differ from that shown in the illustration.

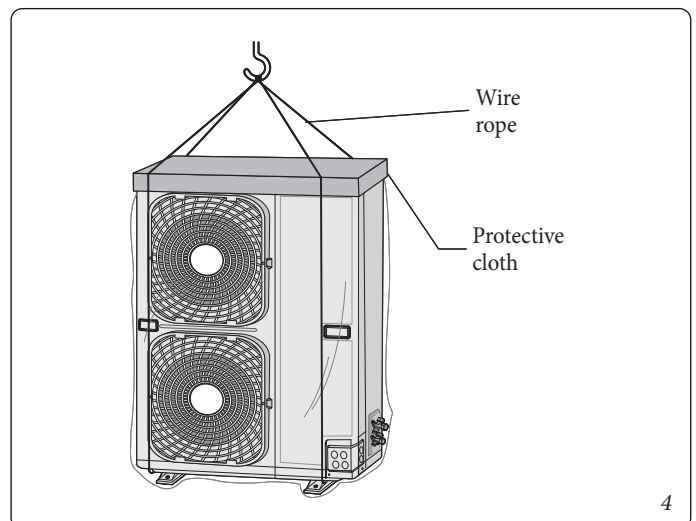

#### 4.4 REQUIRED SPACES.

##### Installation of an outdoor unit.

(Unit: mm)

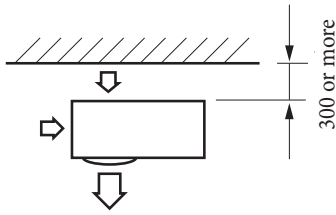

When the air outlet is opposite the wall

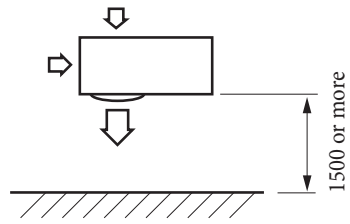

When the air outlet is towards the wall

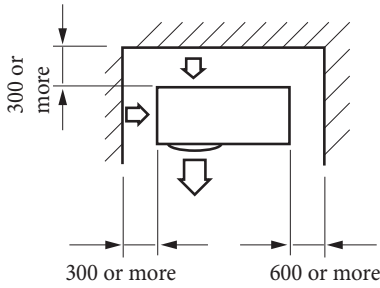

When 3 sides of the outdoor unit are blocked by the wall

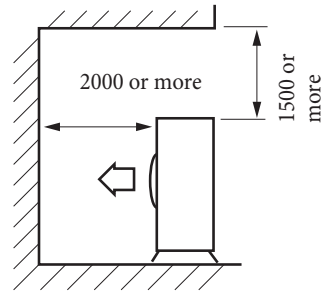

The top of the outdoor unit and the air outlet are towards the wall

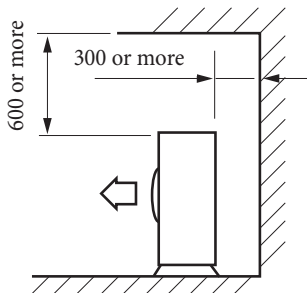

The top of the outdoor unit and the air outlet are opposite the wall

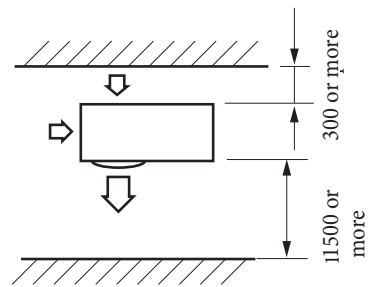

When the front and rear parts of the outdoor unit are towards the wall

Installation of several outdoor units.

(Unit: mm)

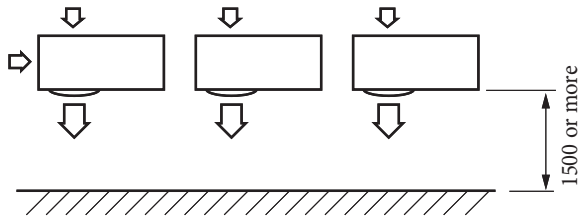

When the air outlet is towards the wall

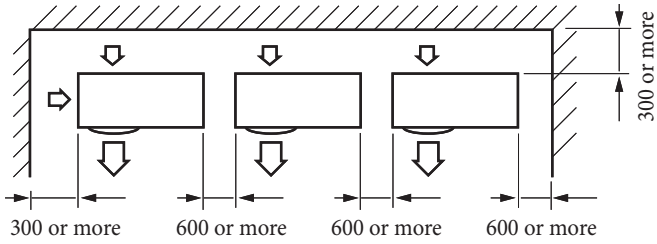

When 3 sides of the outdoor unit are blocked by the wall

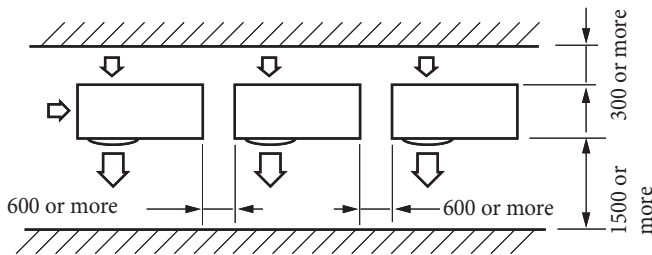

When the front and rear parts of the outdoor unit are towards the wall

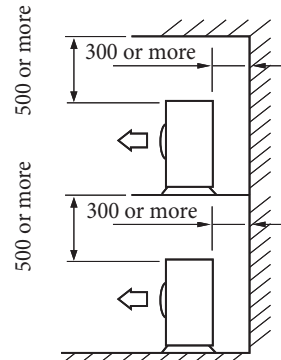

When the top of the outdoor unit and the air outlet are opposite the wall

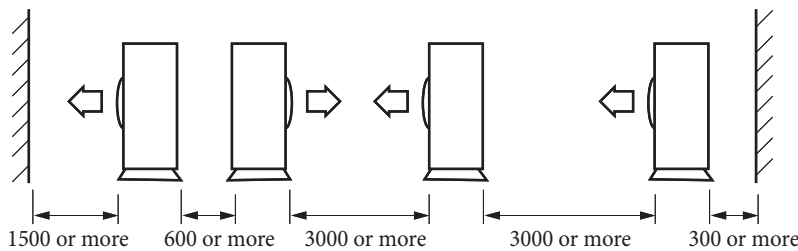

When the front and rear parts of the outdoor unit are towards the wall

**ATTENTION:**



To ensure the proper functioning of the outdoor unit and accessibility from all sides for maintenance, service and repair, it is essential to leave the distances specified above. The outdoor unit must be able to be maintained and repaired in conditions of safety (or persons or objects).

#### 4.5 INSTALLING THE OUTDOOR UNIT.

The appliance must be installed on a rigid and stable base to prevent any increase in noise or vibration. In particular if it is exposed to strong winds and when installed overhanging, it must be fixed to a frame that is able to support its weight and that is adequately fixed to the load bearing structure (floor or wall).

The appliance must always be fixed by means of anchor screws.

The anchor bolt must be at least 20 mm from the base surface (Fig. 9).



#### ATTENTION:

- To prevent corrosion, it is necessary to place rubber washers between the feet of the appliance and the tightening nuts screwed onto the anchor screws.
- A drainage channel must be built around the base.
- When the appliance is to be installed on a roof, it is necessary to ensure in advance that the latter is able to withstand its weight and that it is watertight.



#### 4.6 MOUNT OF OUTDOOR UNIT.

##### Outdoor unit installed on wall frame.

- The wall on which the frame is fixed must be able to support the weight of the outdoor unit plus that of the frame.
- It is advisable to fix the frame in a point that is as close as possible to any columns.
- Install adequate gaskets to reduce noise and residual vibration transferred from the unit to the wall.

#### ATTENTION:

In case of installation of an air conveyor, be careful not to damage the pipes with the fixing screws.

Fix the conveyor to the fan protection grid.

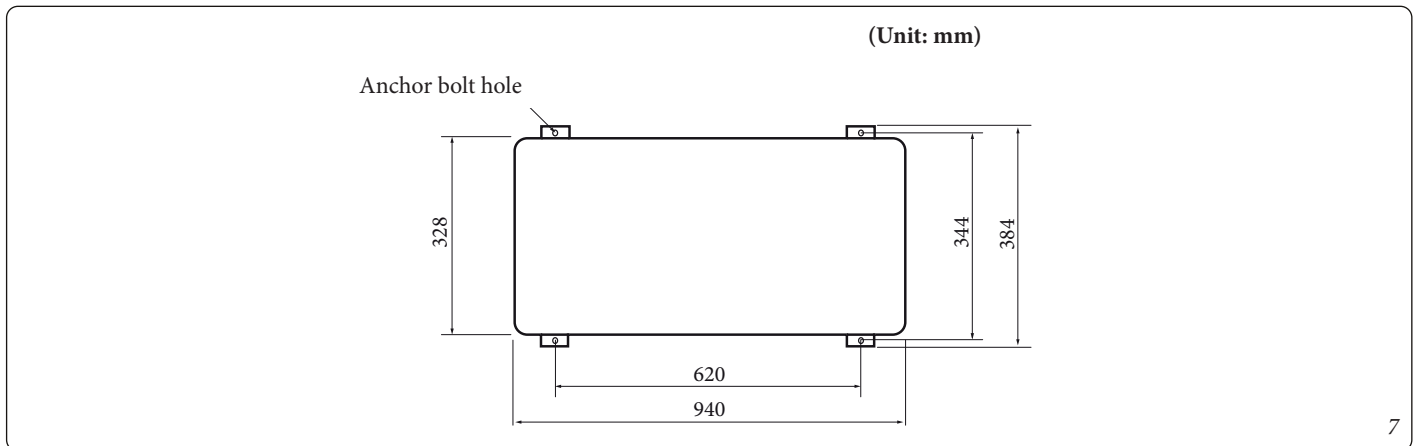

7

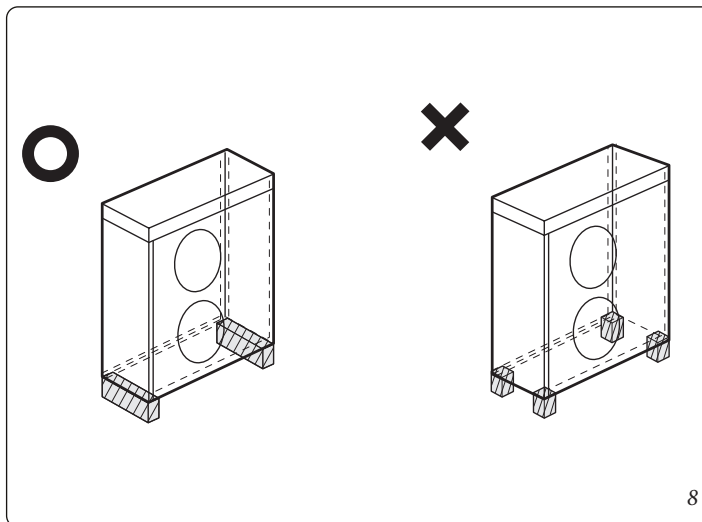

8

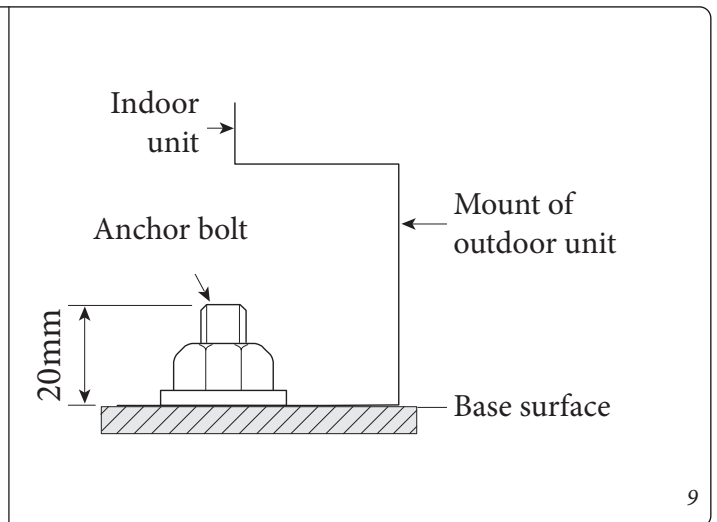

9

#### 4.7 DRAINAGE OF THE OUTDOOR UNIT.

##### General Area

During heating operation, ice deposits may occur on the external surface of the refrigerant-air exchanger.

To prevent the amount of these deposits from increasing too much, the appliance performs defrosting cycles to melt those deposits.

The resulting water from this process is disposed of through the drainage holes to prevent it from re-solidifying on the bottom of the appliance when the external temperature is rather low.

- If for any reason it is impossible to allow this water to drain freely it would be necessary.
- Leave the appliance raised by at least 100 mm with respect to the support surface (Fig. 10).
- Insert the drain sleeve in one of the three drainage holes on the bottom of the appliance and plug the other three with the drain plugs supplied.
- Connect a hose to the drain hose that conveys the water to the desired place.
- Make sure that no dust, debris and/or insects can enter this hose.

##### ATTENTION:

**If the water produced by the outdoor unit was not drained sufficiently, the performance of the entire system would suffer a negative impact and the system itself could be damaged.**



1. All around the base of the unit, dig a water drainage channel that can properly drain the water and condensate produced by the unit.
2. To facilitate drainage, the unit can be installed on a concrete prism base so that the unit is raised by at least 150 mm above the walking surface.
3. The unit should be raised by at least 150 mm above the floor to prevent its flooding in the event of heavy rain.
4. If the installation takes place in a snowy area, the unit should be raised with respect to the floor of an altitude equal to at least the height of the strongest foreseeable snowfall.
5. If the unit is installed overhanging (Fig. 13), it would be appropriate to place a collection tray under it (not included in the supply) that collects and drains in a controlled manner the condensate that could drip from the appliance.

##### Area with intense snowfalls (natural drain)

Ice can build up when using the heat pump in central heating mode. During de-icing (defrosting operation), the condensate water must be drained safely. For the heat pump to work properly, follow the instructions below.

- Leave more than 80 mm between the bottom of the outdoor unit and the ground for the installation (Fig. 11).
- If the product is installed in a region with heavy snowfalls, leave sufficient space between the product and the ground (Fig. 14).
- When you install the product, make sure that the mount is not positioned below the drain hole.
- Make sure that the drain water flows out correctly and safely.

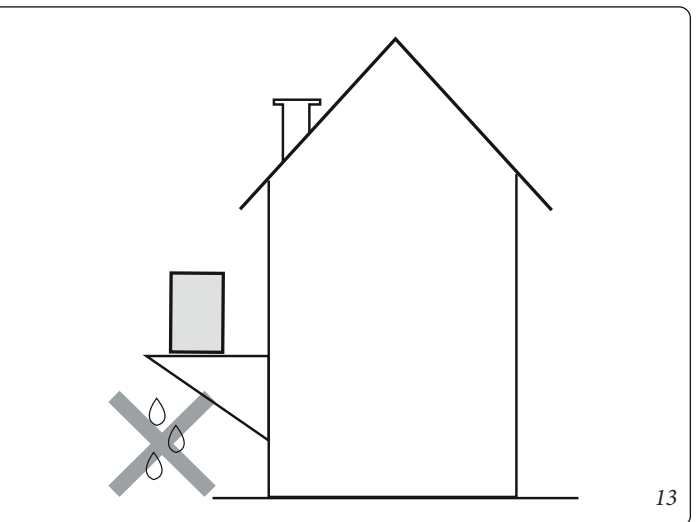
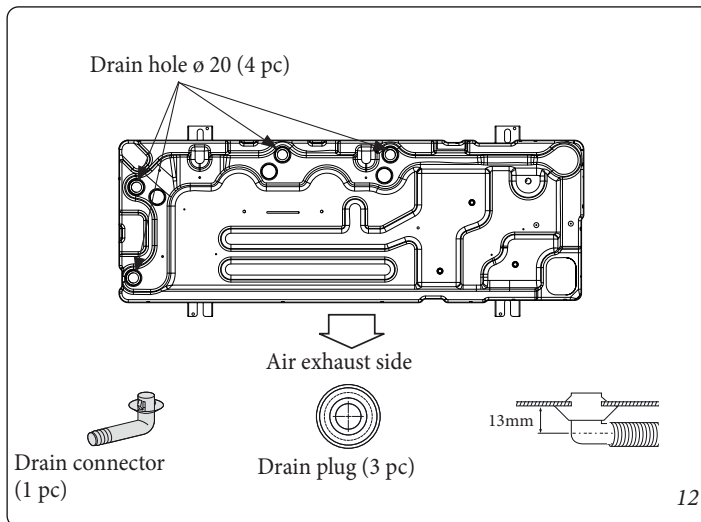
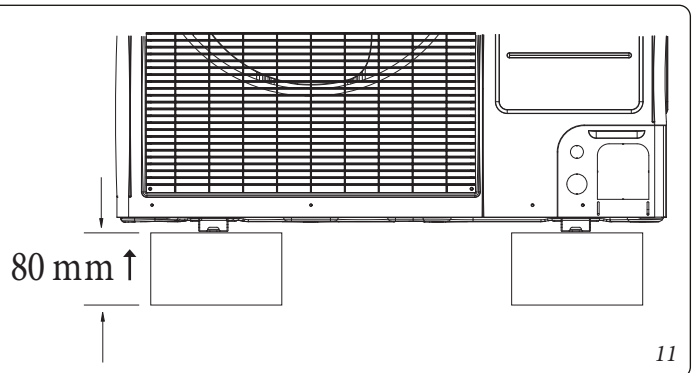
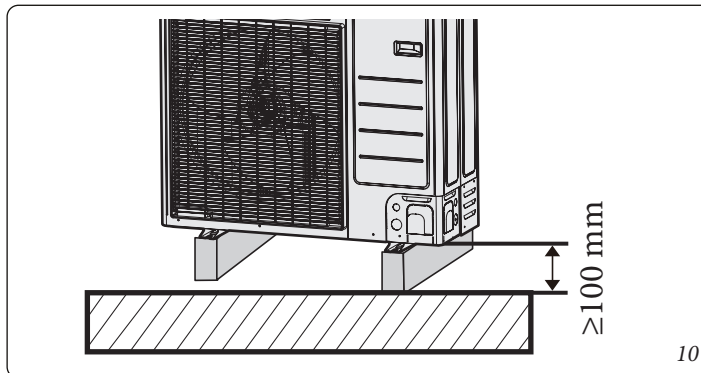

## ATTENTION:

- In zones subject to heavy snowfalls, the accumulated snow could block in the air vents. To avoid this occurrence, install a frame higher than the estimated level of the snow. Furthermore install a snow-proof roof to prevent the snow from piling up on the outdoor unit.
- Potential accumulated ice on the base could seriously damage the product (e.g. the shore of a lake in very cold areas, the coastline, an alpine region, and so on).
- In an area with heavy snowfall, do not install the drain plug and the drain cap in the outdoor unit. It could cause ice to form on the ground. Therefore, take appropriate measures to prevent the inconvenience.



### 4.8 POSITIONING THE UNIT IN A RIGID CLIMATE.

To operate the appliance in low temperature outside environmental conditions, follow the instructions below.



- To avoid exposure to wind, install the unit with the intake side facing the wall.
- Do not install the unit in a place where the intake side can be directly exposed to the wind.
- To avoid exposure to the wind, install a deflector on the delivery side of the unit.

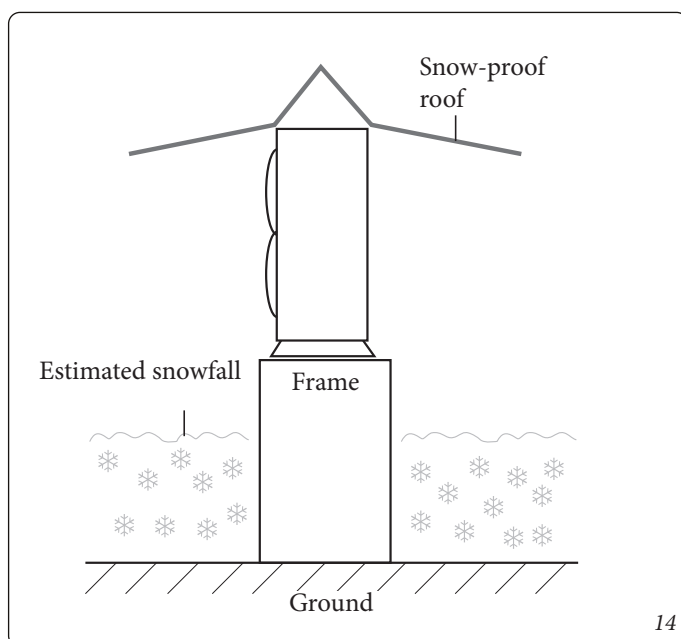

14

- In areas subject to heavy snowfalls, it is very important to choose an installation site where snow does not affect the unit. If necessary, the coolant/air exchanger should also be protected from snow (if necessary, build a side snow cover) (Fig. 15).
  1. Create a canopy that also protects the sides of the unit.
  2. Create a base that elevates the device from the floor by a greater height at the height of the worst foreseeable snowfall.
    - Prevent the unit from being even partially buried by snow.
- By turning the K6 switch to ON, the fan inside the device works in such a way as to prevent snow from accumulating inside the device itself.
- The outdoor unit must be installed considering the direction of strong winds. Therefore the side of the unit, and not the front, should face the wind (Fig. 16).

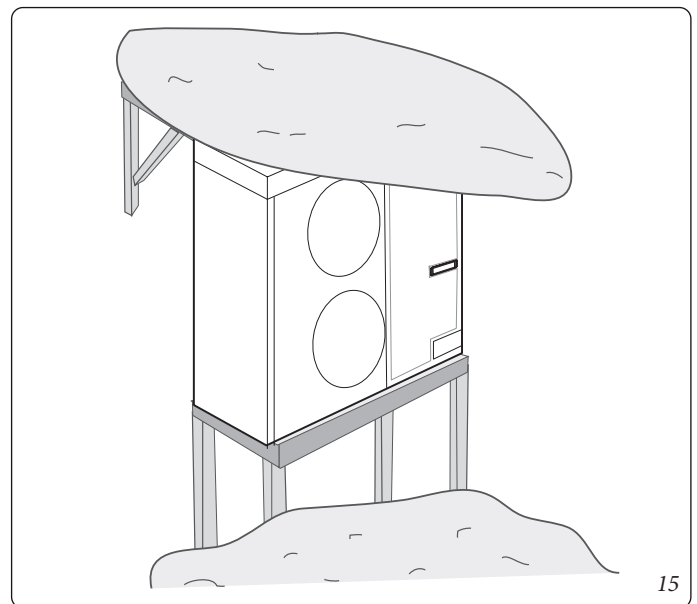

15

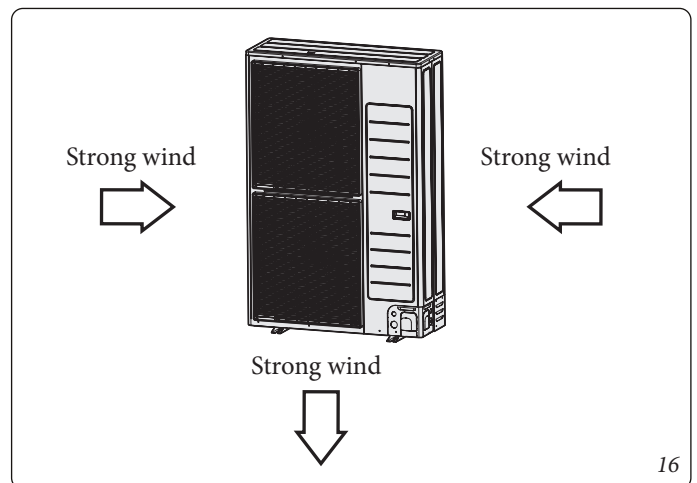

16



# 5 ELECTRICAL CONNECTIONS.

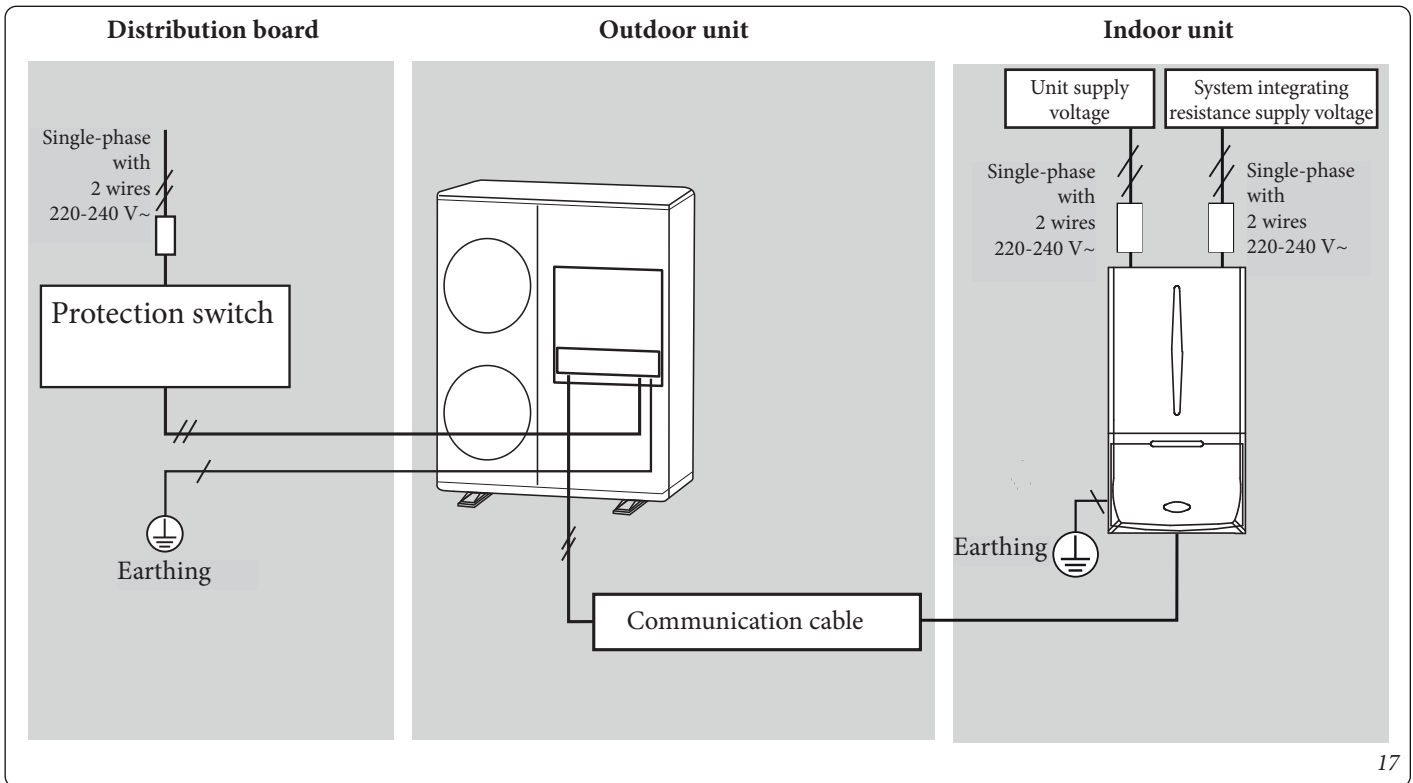

## 5.1 GENERAL CONFIGURATION OF THE SYSTEM.

Connection of power cable (single phase / 2 wires).



17

### ATTENTION:

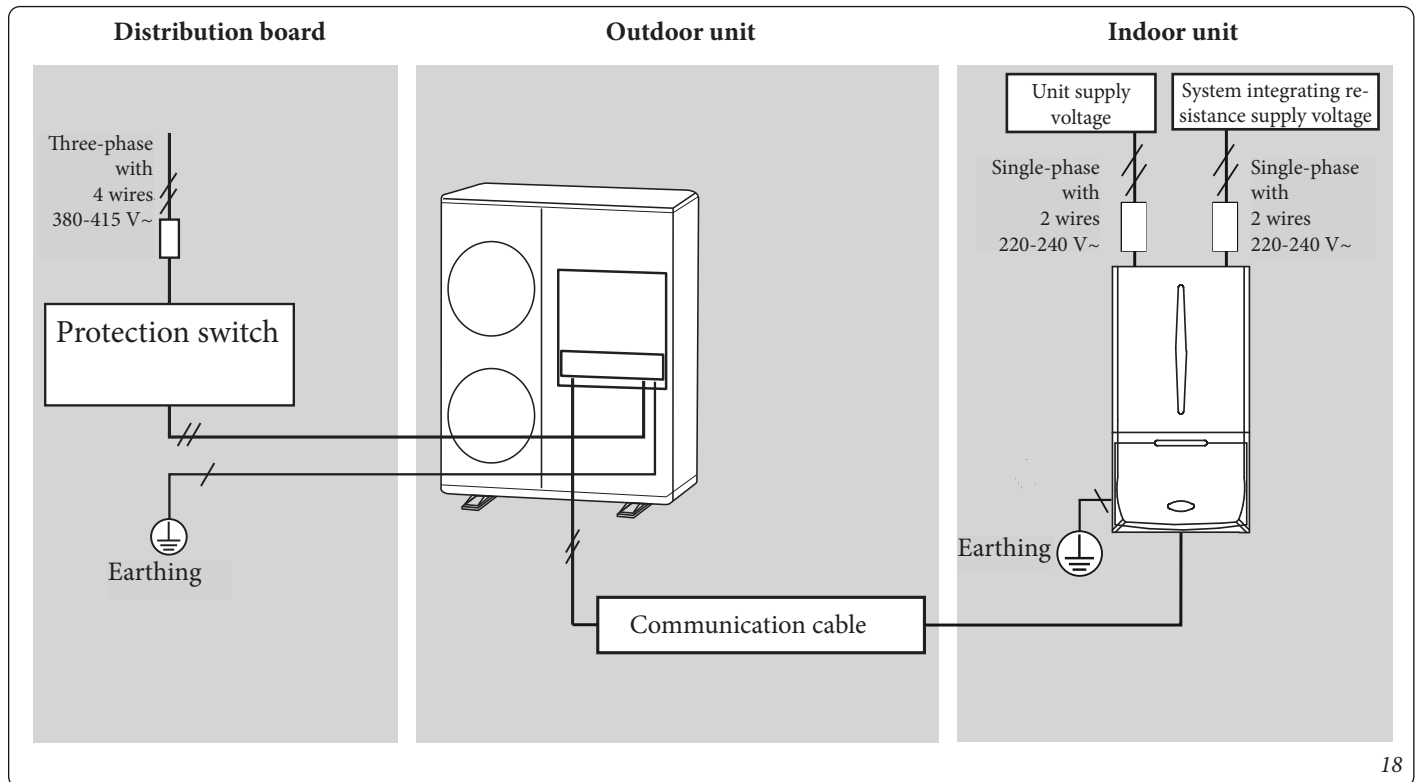

- For service and emergency needs, the electrical panel should be located near the outdoor unit. 
- The magnetothermic switch must be equipped with protection against overcurrents and against earth leakage. 

Connection of power cable (three-phase / 4 wires).



18

**ATTENTION:**

- For service and emergency needs, the electrical panel should be located near the outdoor unit. 
- The magnetothermic switch must be equipped with protection against overcurrents and against earth leakage. 

# 6 CONNECTION OF THE CABLE.

## 6.1 POWER CABLE SPECIFICATIONS.

### Single-phase unit

Outdoor unit	Rated Values		Tolerable Voltage Range		MCA	MFA
	Hz	Volt	Min	Max	Minimum Circuit Current	Fuse rating
UE AUDAX PRO 12 V2	50	220-240	198	264	28 A	35 A
UE AUDAX PRO 14 V2	50	220-240	198	264	30 A	37.5 A
UE AUDAX PRO 16 V2	50	220-240	198	264	32 A	40 A

- The power cable is not supplied with the condensing unit.
- The power cables must be suitable for outdoor installation and have at least one flexible polychlorophene sheath (Code IEC:60245 IEC 57 / CENELEC:H05RN-F).
- This appliance complies with standard IEC 61000-3-12.

### Three-phase.

Outdoor unit	Rated Values		Tolerable Voltage Range		MCA	MFA
	Hz	Volt	Min	Max	Minimum Circuit Current	Fuse rating
UE AUDAX PRO 12 V2 T	50	380-415	342	457	10 A	16.1 A
UE AUDAX PRO 14 V2 T	50	380-415	342	457	11 A	16.1 A
UE AUDAX PRO 16 V2 T	50	380-415	342	457	12 A	16.1 A

- The power cable is not supplied with the condensing unit.
- The power cables must be suitable for outdoor installation and have at least one flexible polychlorophene sheath (Code IEC:60245 IEC 66 / CENELEC:H07RN-F).
- This appliance complies with standard IEC 61000-3-12. The device complies with the dictates of the IEC 61000-3-12 standard provided that the short-circuit power  $S_{sc} \geq 3.3$  MVA at the interface point between the user's network and the public network. It is the responsibility of the installer or user to contact the electricity supplier to ensure that the appliance is connected to a power supply with  $S_{sc} \geq 3.3$  MVA].

## 6.2 SPECIFICATIONS OF THE CONNECTION CABLES (COMMONLY USED).

Communication cable
Two wires of 0.75~1.5mm <sup>2</sup>

- The connection cable must be of type H07RN-F or type H05RN-F.

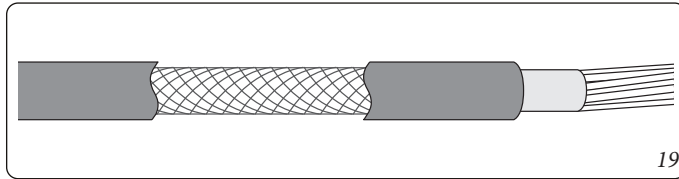

19

- If the outdoor unit is installed in a computer room, in a network room or in a server room, or where there is the risk of disturbance of the communication cable, use a double-shielded communication cable (aluminium tape/polyester + copper braid) type FROHH2R.

## 6.3 SPECIFICATIONS OF SINGLE-PHASE TERMINAL BLOCK.

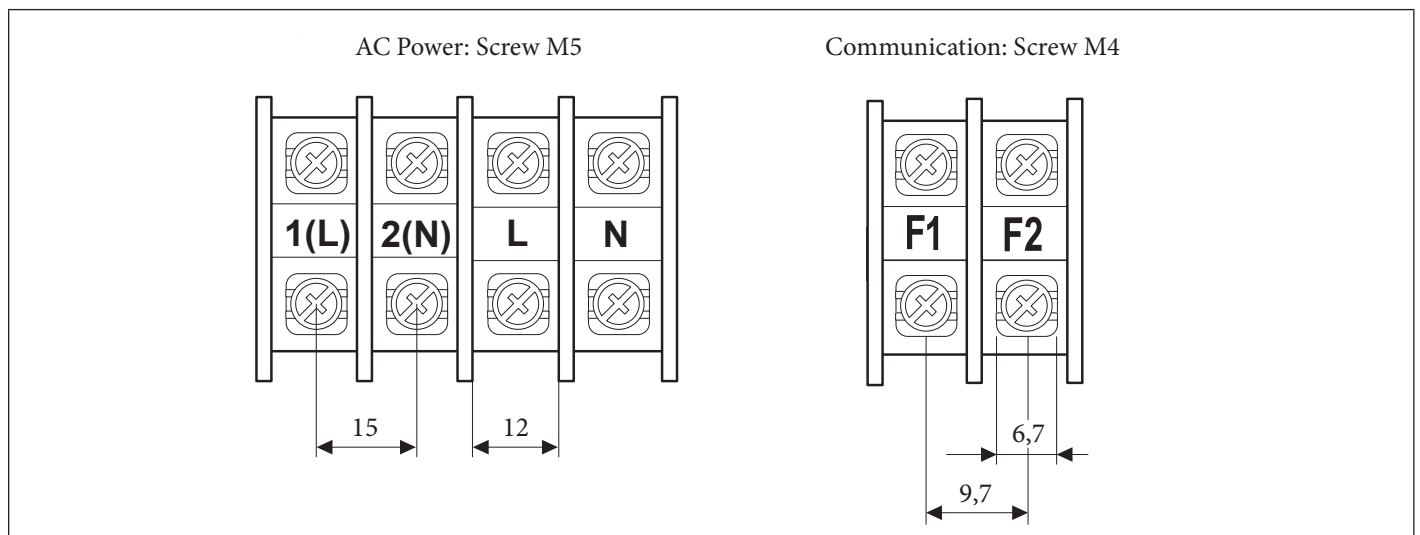

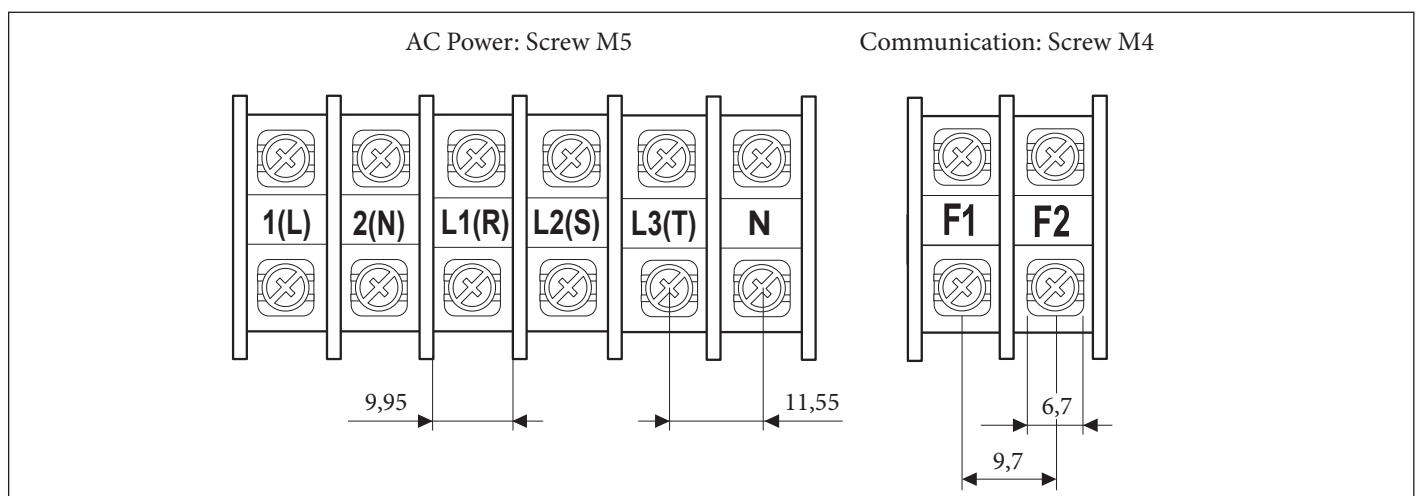

## 6.4 SPECIFICATIONS OF THREE-PHASE TERMINAL BLOCK.

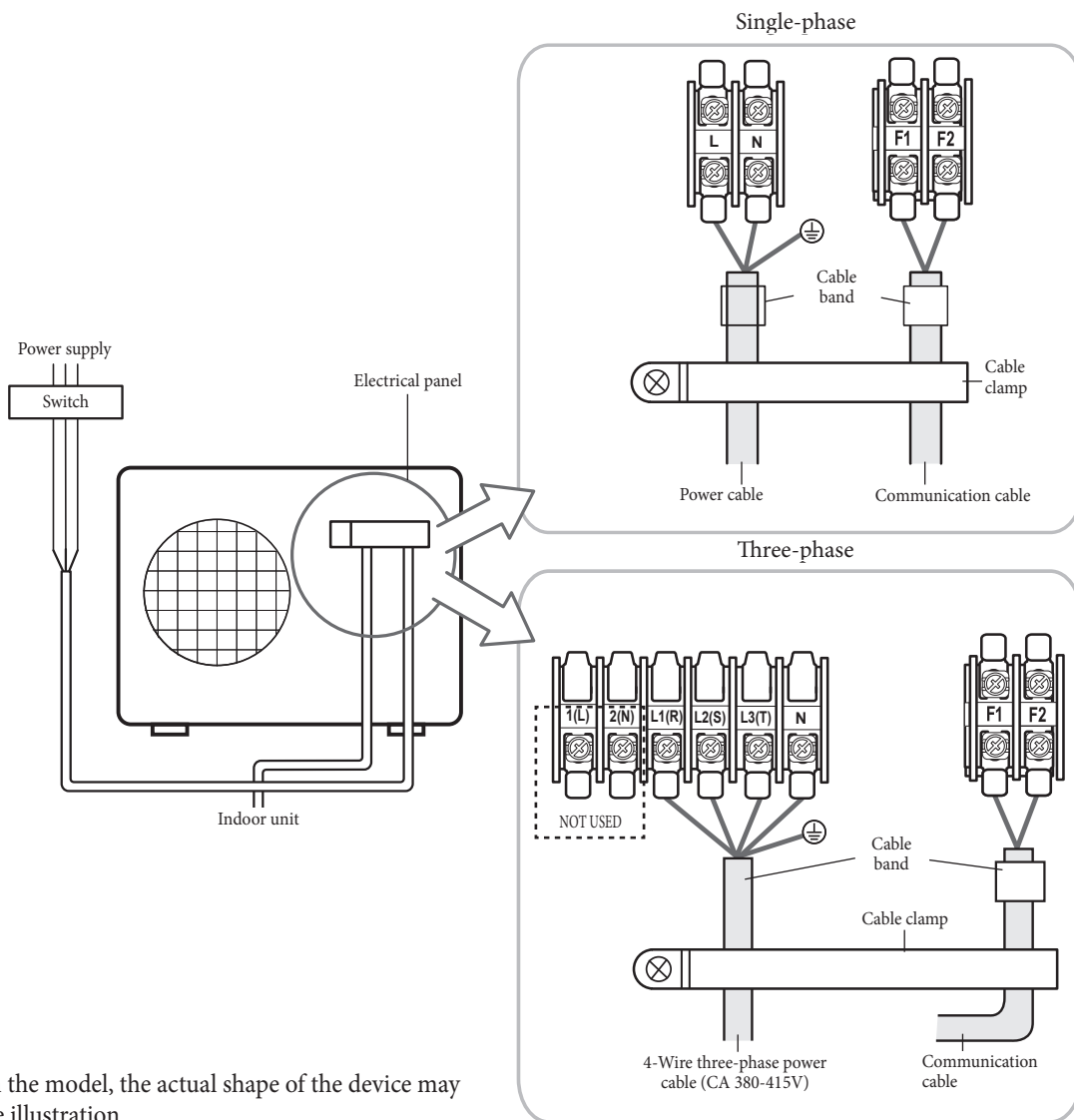

## 6.5 POWER CABLE CONNECTION DIAGRAM.



## ATTENTION:

- After the connection to the terminal block, the power cable must be fixed using a cable clamp. 
- Power imbalance must not exceed 2% of the rated voltage. 
- Otherwise, the life of the capacitor could be shortened. If the power imbalance exceeds 4 % the supply power, the indoor unit protection trips, the unit stops and the error mode is indicated.
- To protect them from water and any mechanical trauma, the power and communication cables must be laid in conduits (With an adequate protection rating IP in accordance with the needs of the specific application).
- Check that the main power connection is performed by means of an omnipolar switch, with a contact opening of at least 3 mm.
- In case of overvoltage, all equipment connected to the power supply line must automatically disconnect.
- Maintain a distance of 50 mm or more between the power cable and the communication cable.

## Single-phase with 2 wires

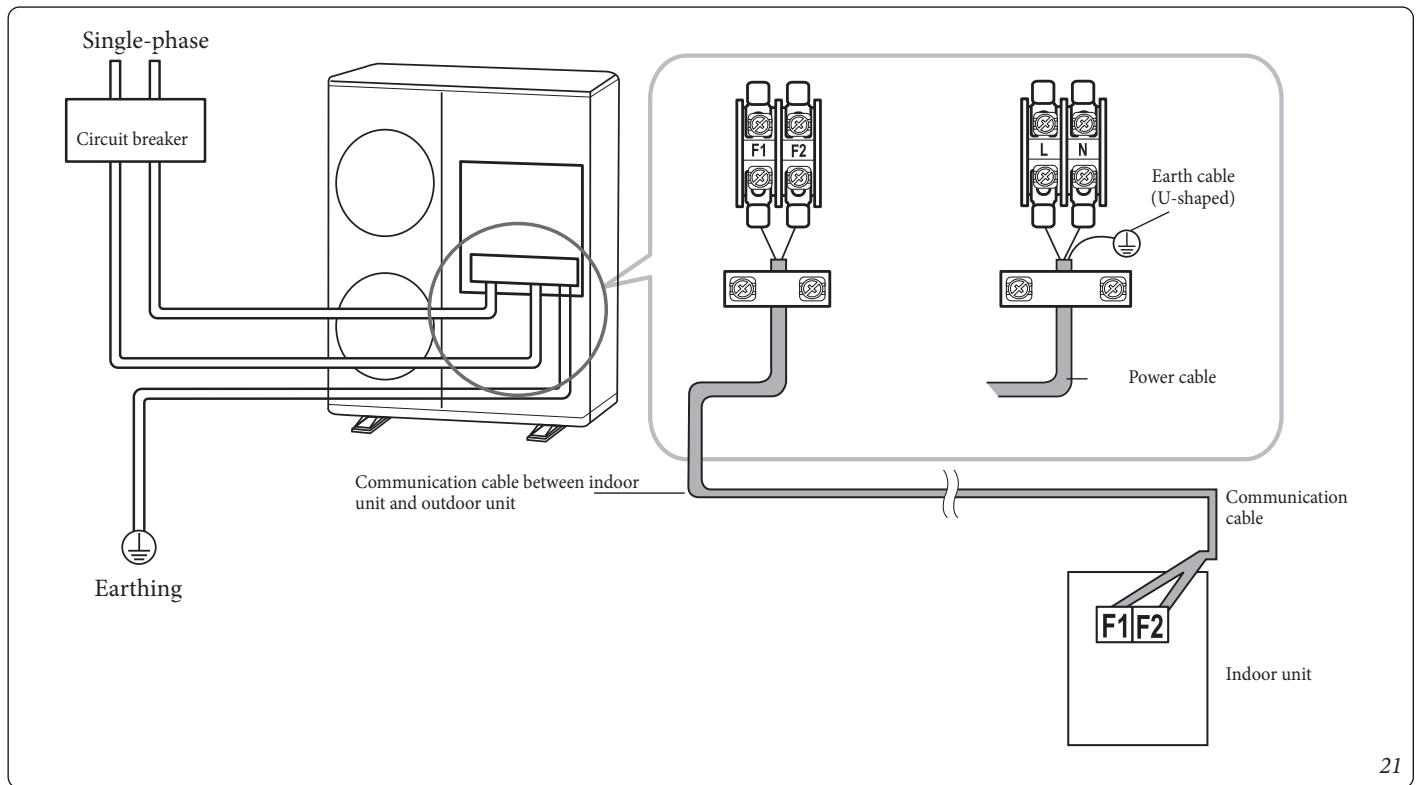

21

### ATTENTION:

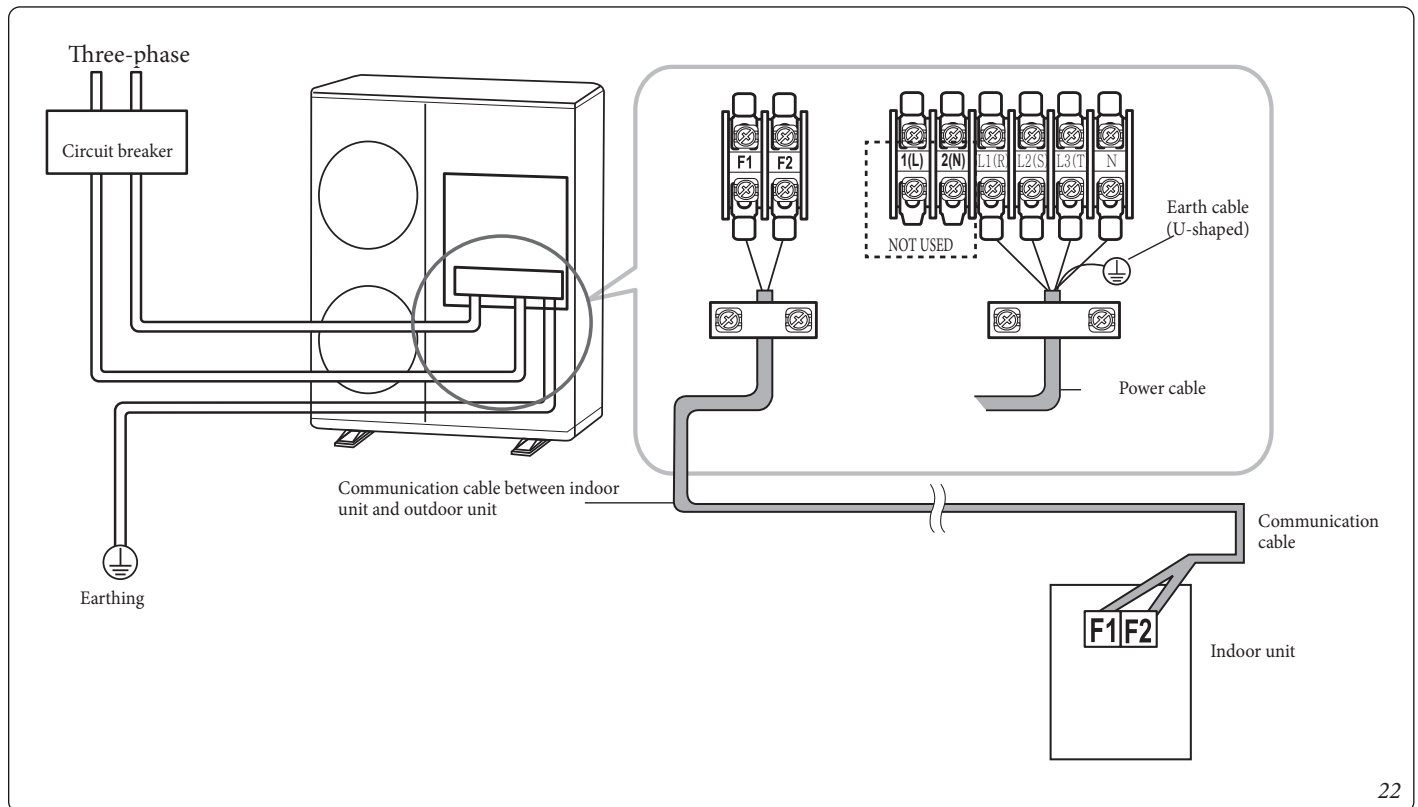

- When the outer cover of the power cable is removed, use appropriate instruments to avoid damaging the internal casing. ⚠️ ⚡
- Inside the electrical panel, the position of the power cable outlet and the communication cable must be at least 20 mm away from each other.
- The communication wiring should be made separately from the power cable and from other communication cables.

### Three-phase - connection with 4 wires



22

#### ATTENTION:

- When the outer cover of the power cable is removed, use appropriate instruments to avoid damaging the internal casing. 
- Inside the electrical panel, the position of the power cable outlet and the communication cable must be at least 20 mm away from each other. 
- The communication wiring should be made separately from the power cable and from other communication cables.



## 6.6 CONNECTION OF POWER TERMINAL BLOCK.

- The connection must be made after having fixed the cables to ring compressed terminals.
- Use only cables of the specified types.
- Only screwdrivers capable of transmitting the prescribed tightening torques to the screws must be used for the connection.
- If the connection is loose, electric arcs could be ignited which could in turn cause fires. If the connection is tightened too much, the terminal could be damaged.

Tightening torque (kgf.cm)	
M4	12~18
M5	20~30

## 6.7 EARTHING.

- For safety reasons it is essential that the earth connection be carried out by a qualified electrician.
- Use only cables of the types specified in the characteristics of the appliance cables.

### Power cable earthing

- Earthing standards may vary depending on the rated voltage of the place of installation of the condensing unit.
- The characteristics of this connection must however be the following:



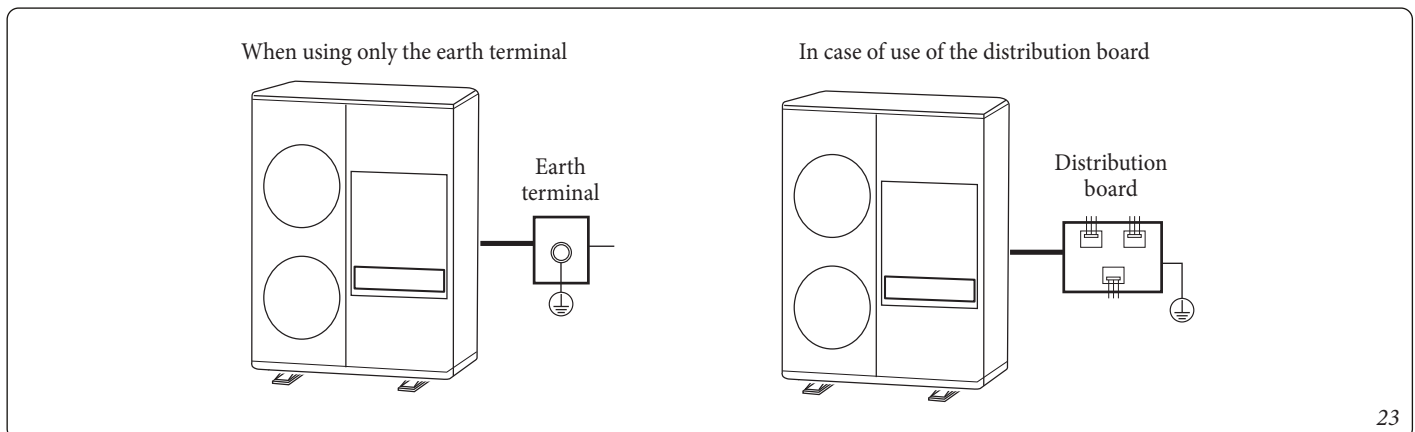

Place of installation	High humidity	Average humidity	Low humidity
Power condition			
Electric potential lower than 150 V		Perform earthing in mode 3 (Note 1)	Earthing must be carried out in mode 3 (Note 1)
Electric potential higher than 150 V		Earthing must be carried out in mode 3 (Note 1) (In case of installation of a circuit breaker)	

- (Note 1) Earthing work 3.
- Earthing must be carried out by a qualified electrician.
- Check whether the earth resistance is lower than  $100\Omega$ . When a circuit breaker is installed which can interrupt the electric circuit in case of a short circuit, the admissible earth resistance can be  $30 \sim 500\Omega$ .



## 6.8 HOW TO CONNECT EXTENSION CABLES.



1. Prepare the following instruments:

Tools	Crimping pliers	Connection sheath (mm)	Electrical tape	Thermo-shrinking tube
Specifications	MH-14	20xØ6.5 (AxD.E.)	Width 19 mm	70xØ8.0 (LxD.E.)
Shape				

2. As shown in figure, strip the screen from the rubber and from the wires of the power cable.

- Strip 20 mm of cable shield from the pre-installed pipe.

### ATTENTION:

- For information on the power cable specifications for outdoor and indoor units, refer to the instruction manual. 
- After detaching the cable wires from the pre-installed pipe, it is necessary to insert a thermo-shrinking tube. 

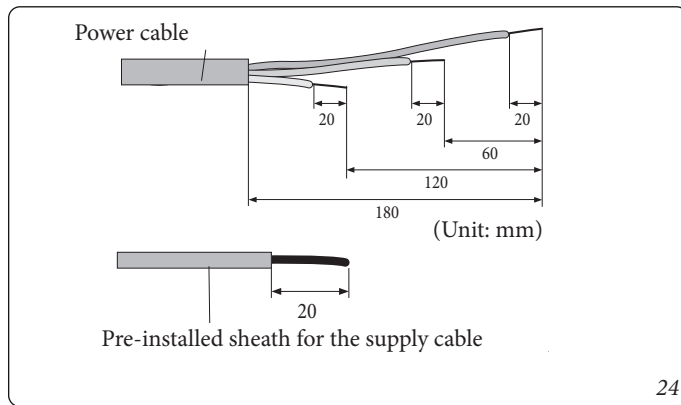

3. Insert both sides of the central wire of the power cable into the connection sleeve.

### Method 1

- Push the power cable into the sheath from both sides.

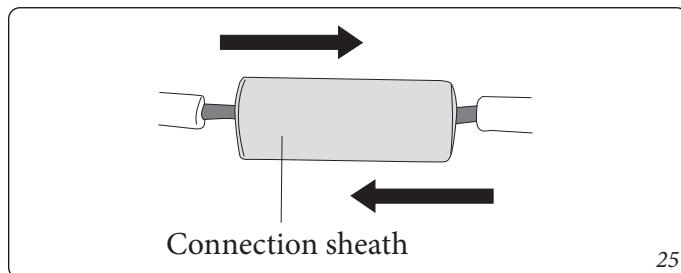

## Method 2

- Twist the copper wires together and push them into the sheath.

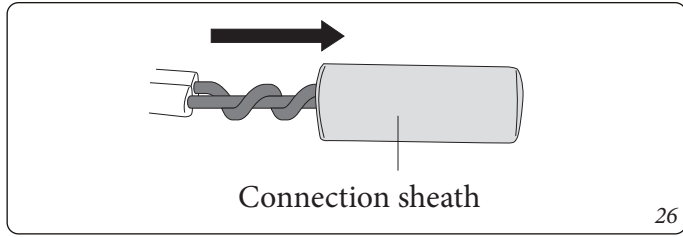

4. Compress the two points with the crimping pliers, turn them and repeat the operation on the other two points in the same position.
  - The compressed dimension should be 8.0.
  - After having squeezed it, pull both ends of the wire to make sure it is firmly compressed.

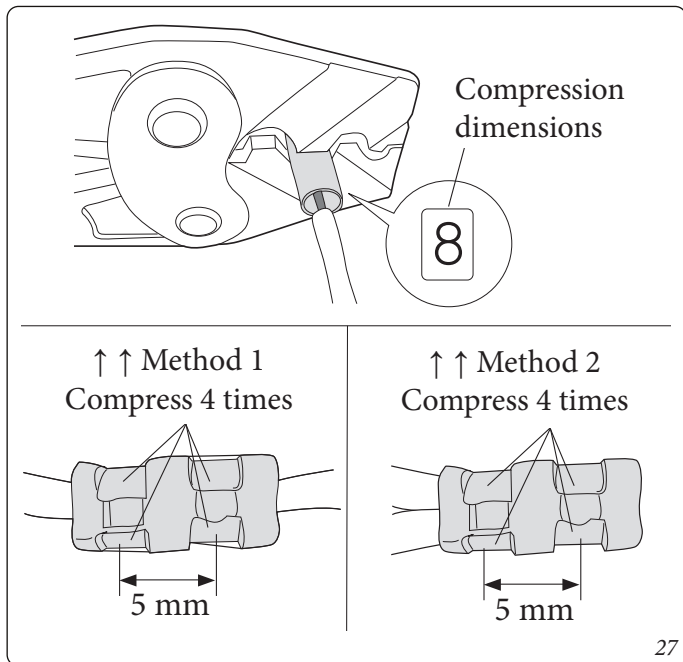

5. Wrap it in at least two turns of electrical tape and position the contraction sheath in the middle of the tape. Three or more layers of tape are required.

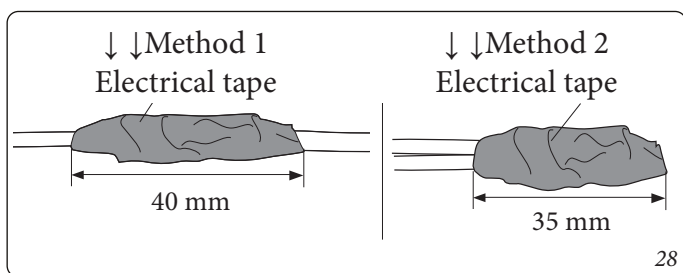

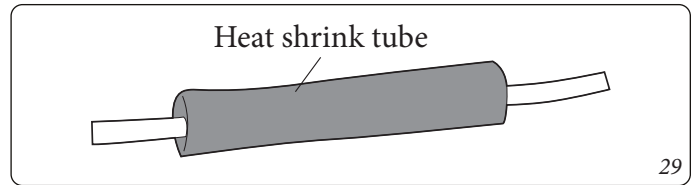

6. Heat the contraction sheath to contract it.





7. After having completed the contraction stage, finish the operation by wrapping it with electrical tape.

### ATTENTION:

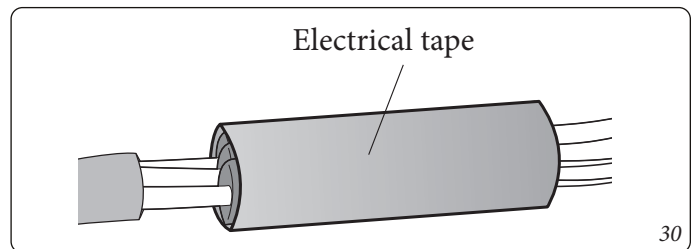
- Make sure that the parts to be connected are not exposed to the outside. 
- Make sure that the electrical tape and the contraction sheath are made with approved reinforced insulating materials with the same voltage and current values as the power cable. (Comply with local standards for the extensions). 



### ATTENTION:

- In case of extension of the electric wire, do NOT use a round press-fit bushing. 
- Incomplete electrical connections can cause electrocutions or fire. 

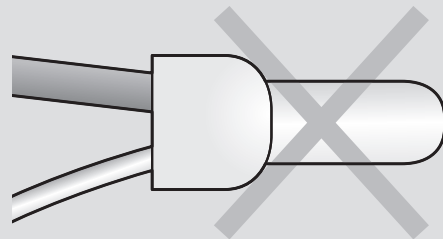

## 7 CHECKING CORRECT EARTHING.

Establish a ground connection in accordance with the law in force, in case the building does not have one or in case it is equipped with a ground connection not in accordance with the law. Everything you need for grounding the electrical system is not part of the supply.

1. Use a pile shoe having the characteristics shown in figure 31.
2. Connect the flexible hose to the coupling.
  - Preferably on a hard or moist ground rather than sandy or gravelly due to the greater earth resistance.
  - The pile shoe should be inserted away from networks or underground water or gas distribution structures, telephone networks or underground cables
  - The pile shoe must be inserted at least two meters away from connection cables and from lightning rods discharge rods.

- The earth connection of the appliance must not be made on earth connection cables for telephone lines.



3. Complete by wrapping electrical tape on the connection lines with the outdoor unit.
4. Connect a green/yellow cable to the pile shoe:
  - If necessary, the earth cable could be extended by welding it to an extension and then carefully taping the joint (which however should never be buried).
  - Firmly secure the earth cable with hooks and clamps.

- The fixing of the earth cable must be all the more secure the more the area in which it runs is subject to traffic.



5. Check the effectiveness of the ground connection using a tester. If the resistance were higher than the required value, it would be necessary to insert the pile into the ground more or to insert other piles.
6. Connect the ground cable to the ground terminal of the outdoor unit.

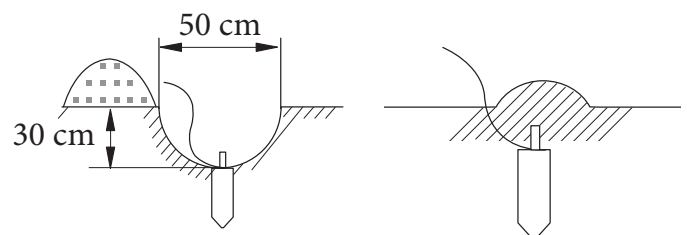
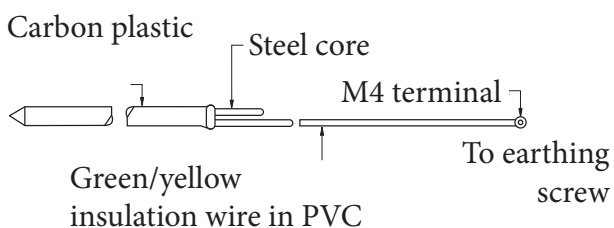

31

# 8 INSTALLATION OF CHILLER LINES.

- The length of the pipes between the outdoor unit and the indoor unit, the difference between the length of the pipes after the first joint and the difference in height must not exceed the indicated limits.
- R410A is a high pressure refrigerant.
- Use only certified refrigeration pipes and follow the installation methodologies given here.
- Use a free refrigerant pipe in an environment without dangerous ions, oxide, dust, iron content or humidity.
- Use instruments and accessories suitable for R410A.

Manifold pressure gauge	- To prevent foreign bodies from entering the refrigeration lines and reading errors, use a manometer manifold for R410A.
Vacuum pump	- Only a vacuum pump with a check valve should be used to prevent the oil contained in it from being drawn back into the refrigeration circuit when it stops. - Use a vacuum pump suitable to reach the necessary degree of vacuum.
Nuts	- Use only the nuts supplied with the product.

## 8.1 GEOMETRIC LIMITS OF THE CHILLER LINES AND EXAMPLES OF INSTALLATION.

Dimensions	Outdoor unit
A	less than or equal to 50 m
H1	less than or equal to 30 m
H2	less than or equal to 15 m

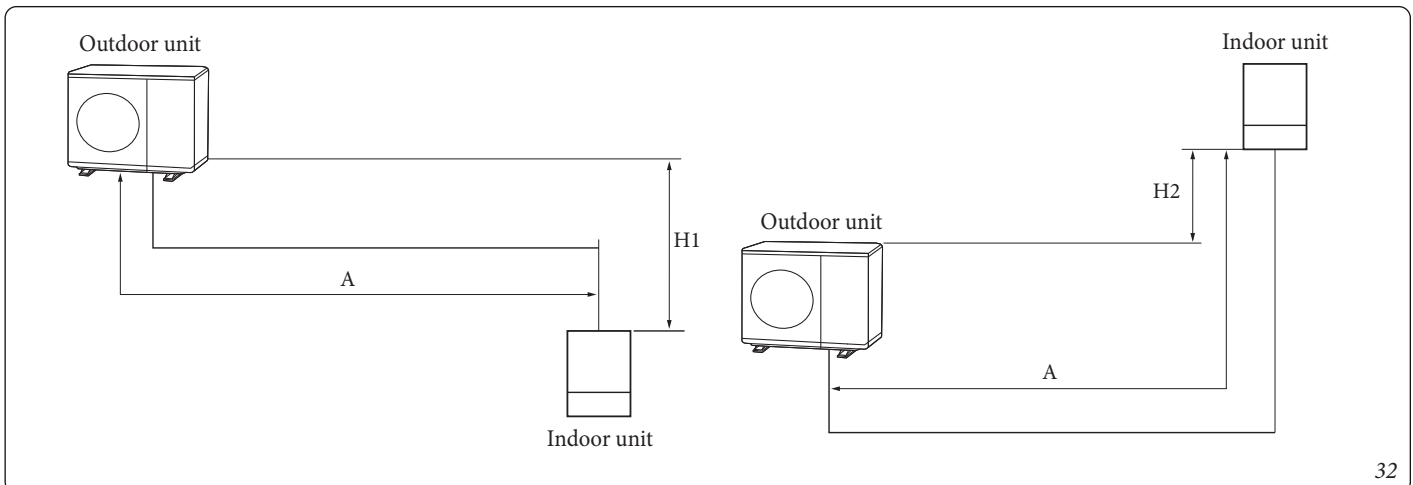

## 8.2 SELECTION OF REFRIGERANT PIPE.

Liquid side (mm)	Gas side (mm)
ø 9.52	ø 15.88

- Install the refrigerant pipe depending on the capacity of the outdoor unit.
- The pipes from Ø19.05 inclusive must be of type C1220T-1/2H (semi-rigid). C1220T-O (malleable) piping does not have sufficient resistance to pressure and could fail if used, causing injury.

Outside diameter (mm)	Minimum thickness (mm)	Type of piping
ø 9.52	0.7	C1220T-O
ø 15.88	1.0	
ø 15.88	0.8	C1220T-1/2H OR C1220T-H

- Type and minimum thicknesses of the pipes of the refrigeration lines.

## 8.3 KEEP THE REFRIGERANT PIPE CLEAN AND DRY.

- During installation, to prevent foreign bodies or water from entering the pipe, they must be sealed with plugs.

## 8.4 CUTTING AND FLARING OF PIPES.

1. Make sure to have prepared the required tools.
  - pipe cutter, deburring tool, flaring tool, clamp, etc.
2. If a pipe needs to be shortened, cut it with a pipe cutter, taking care to maintain the cutting angle at 90° with the axis of the pipe itself.
  - In figure 33 are some examples of cuts made correctly and incorrectly.
3. To avoid gas leaks, remove all of the burrs on the pipe cutting edge using a reamer.

### ATTENTION:

- During deburring, the tube must face downwards to prevent chips from entering.

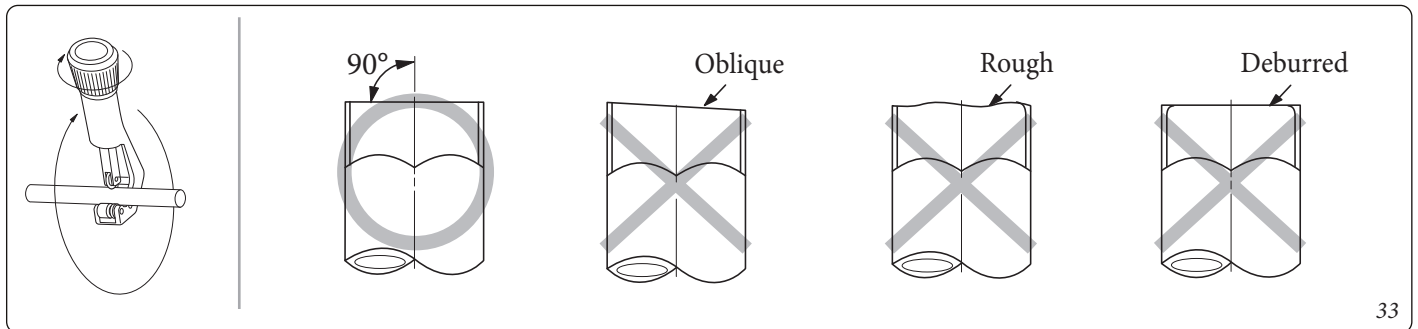

33

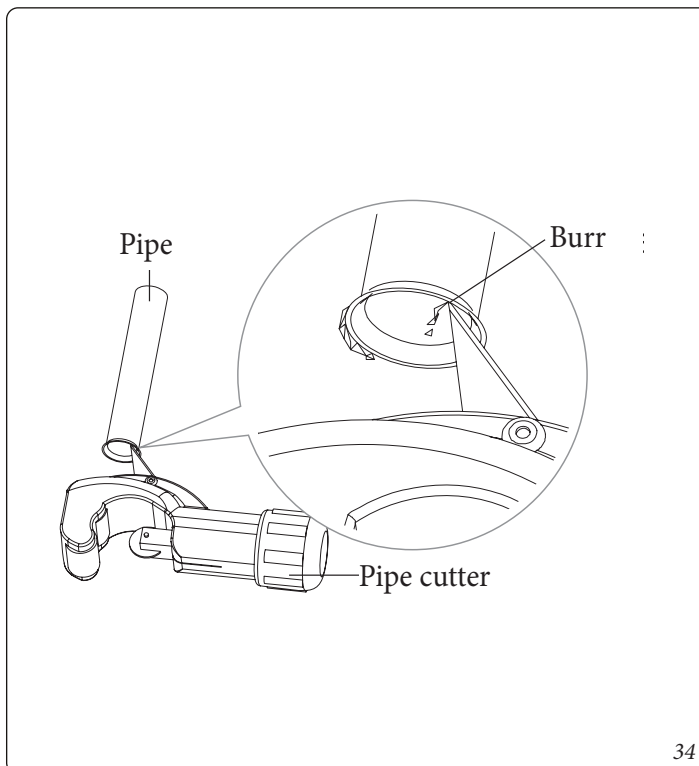

34

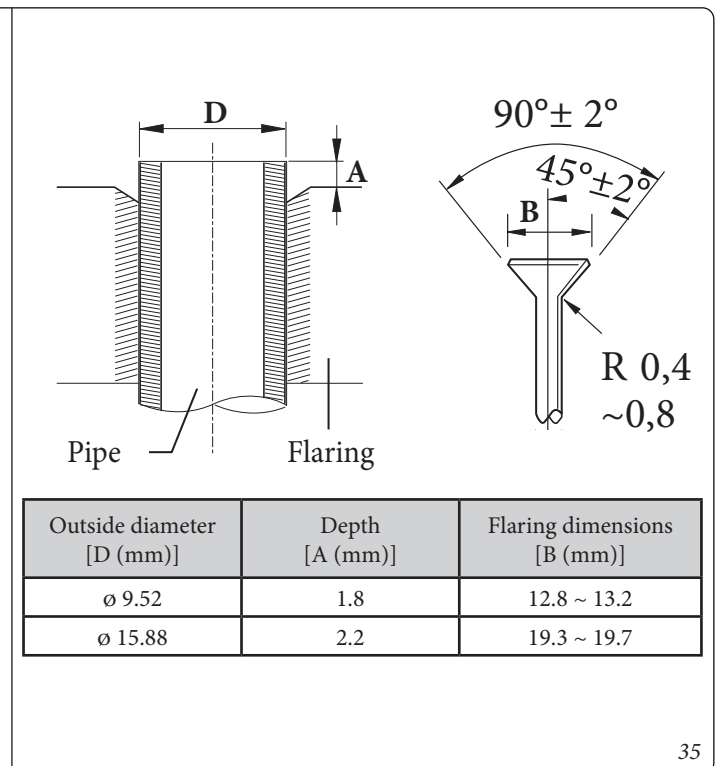

35

4. Insert a countersunk nut into the pipe and modify flaring.
5. Check that the pipe is correctly countersunk.
  - Figure 36 shows some examples of incorrectly countersunk pipes.
6. Align the pipes to connect them easily. Tighten the flare nuts first with your hands, then with a torque wrench, with the following tightening values, indicated in figure 37.

Overtightening can cause refrigerant leaks.



**ATTENTION:**

- Any welding must be carried out in a nitrogen atmosphere.

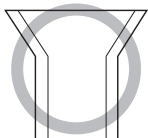

Correct



Sloped

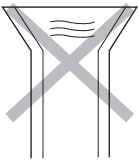

Damaged surface

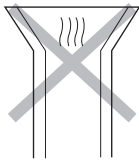

Cracked

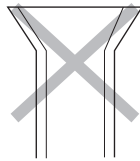

Uneven thickness

36

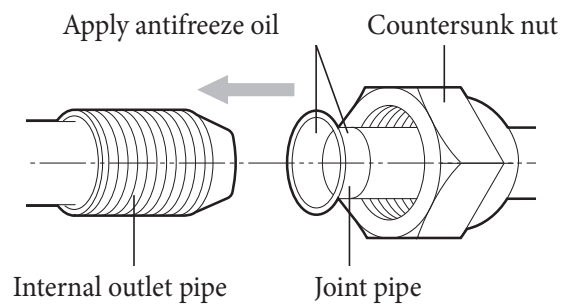

Outside diameter [mm (inches)]	Torque (N·m)
ø 9.52 (3/8")	34~42
ø 15.88 (5/8")	68~82

37

### 8.5 CHOOSE THE INSULATION OF THE REFRIGERANT PIPE.

- The gas and liquid refrigeration lines must be insulated with material selected according to their respective diameters.
- The standard conditions are with a temperature of 30° C and a humidity of 85%. If the thermohygrometric conditions of the air were more severe, it would be necessary to use insulation selectable from the table in figure 38.

#### ATTENTION:



- **The insulation cannot have areas of discontinuity and for this reason its joints must be sealed with adhesives to prevent moisture from infiltrating underneath it.**
- **If it were exposed to sunlight, the insulation should be protected by wrapping it with insulating tape.**
- **Install the insulation making sure that the insulation is not thinner on bends or in the fairlead.**

### 8.6 INSULATING THE REFRIGERANT PIPE.

- The insulation must be laid only after checking that there are no refrigerant leaks from the lines.
- Use an EPDM insulation having the characteristics described in the table in figure 39.

Type of pipe	Pipe diameter (mm)	Insulation thickness		Notes
		Normal (Below 30°C, 85 %)	High humidity (Over 30°C, 85 %)	
		EPDM, NBR		
Liquid	ø 6.35 ~ ø19.05	9	9	The material must be able to withstand heat beyond 120°C
Gas	ø15.88	19	25	

38

Item	Unit	Standard	Notes
Density	g/cm <sup>2</sup>	0.048 ~ 0.096	KSM 3014-01
Path dimensions changed by heat	%	-5 or less	
Water absorption rate	g/cm <sup>2</sup>	0.005 or less	
Thermal conductivity	kcal/m·h·°C	0.032 or less	KSL 9016-95
Moisture transpiration factor	ng/(m <sup>2</sup> ·s·Pa)	15 or less	KSM 3808-03
Moisture transpiration degree	{g/(m <sup>2</sup> ·24h)}	15 or less	KSA 1013-01
Dispersion of formaldehyde	mg/l	-	KSF 3200-02
Oxygen rate	%	25 or less	ISO 4589-2-96

39



- The refrigeration lines, joints and connections must be insulated with class 'o' material.
- Good insulation prevents condensation on the surface of the pipes and safeguards the performance of the outdoor unit and the degree of user satisfaction.
- Check that the insulation has no breaks and/or discontinuities in correspondence with the bends of the pipes.

## 8.7 PIPE WELDING.

- Make sure there is no moisture inside the pipe.
- Make sure there are no foreign bodies or impurities in the pipe.

### Use of Nitrogen.

1. The welds must be carried out in a nitrogen atmosphere, i.e. by blowing nitrogen into the pipes as shown in the figure 40.
2. If the welds were carried out without blowing nitrogen inside the pipes, oxide flakes would form. When these flakes come off, they could damage the compressor and the valves.
3. Adjust the flow of the replacement gas with a pressure regulator to maintain the flow rate no lower than 0.05 m<sup>3</sup>/h.
4. The valves must be protected from heat during their welding.

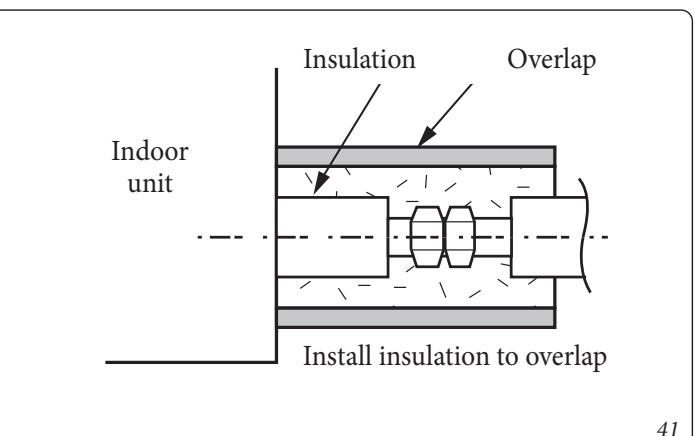
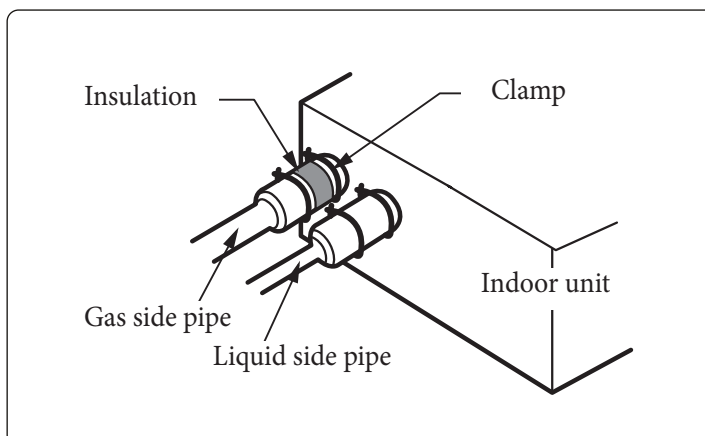
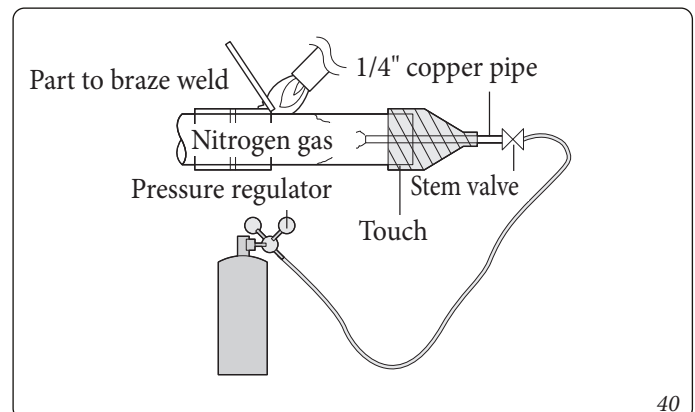

## 8.8 PRESSURE TEST AND SEARCH FOR LEAKS.

- To prevent the entry of foreign substances into the circuit and to ensure the essential resistance to the pressures involved, it is essential to use only a manifold with pressure gauges for R410A.
- The pressure test must be performed using only anhydrous nitrogen.

The liquid and gas lines must be pressed with nitrogen to 4.1 MPa (41.8 kgf/cm<sup>2</sup>)

Higher pressures could damage the circuit. It is therefore good to carry out the pressing using a pressure regulator.

Once pressed, leave everything in rest and after 24 hours check that the pressure has not decreased.

Any pressure variations can be controlled by means of the pressure regulator.

Should the pressure decrease, the leaks should be sought and eliminated.

The leaks can be identified by means of a foaming agent. Once identified, the leaks must be eliminated. Finally, check the pressure tightness again.

Maintain a pressure of 1.0 MPa and perform a further search for leaks before vacuuming and dehydrating the circuit.

After having eliminated any leaks, it is necessary to maintain the pressure at 1.0 MPa and again check for any leaks.

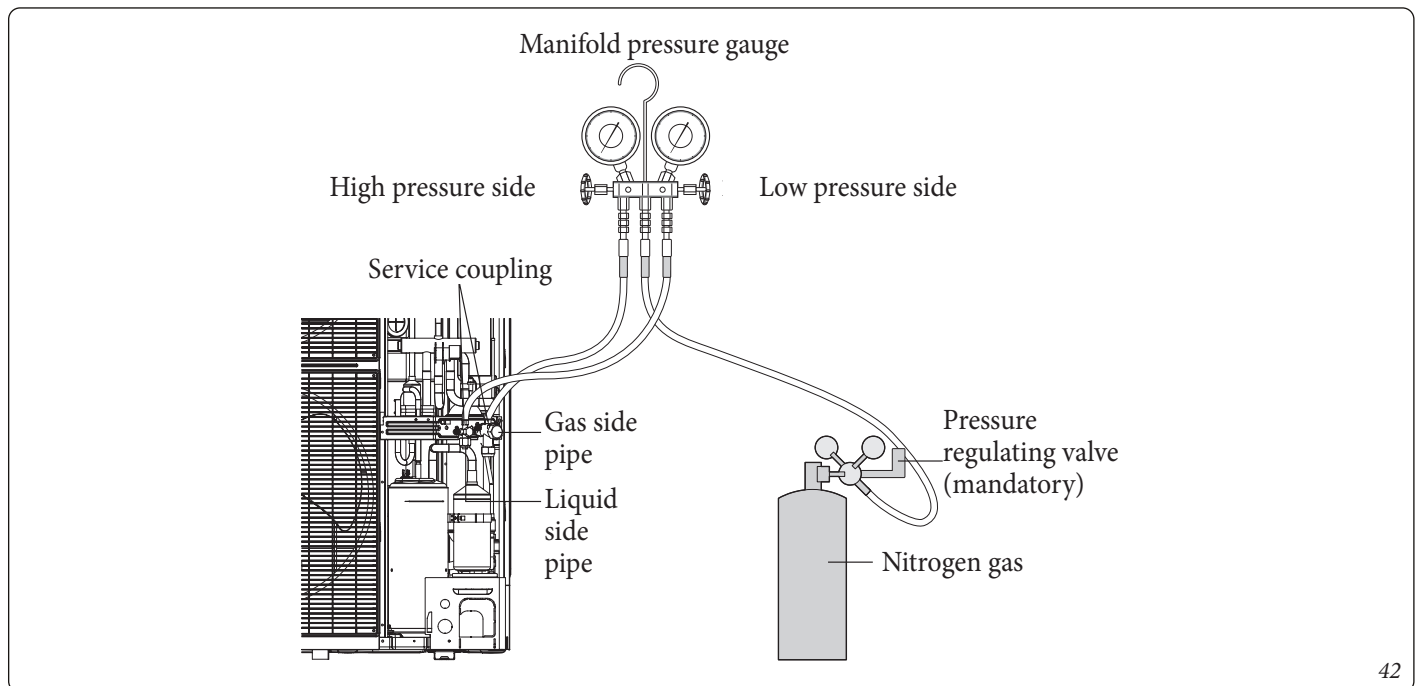

- Make sure to use a solution for the recommended bubble test to look for gas leaks. Soapy water could cause cracks in the countersunk nuts or corrode the countersunk joints.

### ATTENTION:

- **If a gas connection is disconnected, the gas that escapes could cause injuries when it comes into contact with people. To prevent these accidents, the connections must be properly tightened.**



### 8.9 VACUUMING AND DEHYDRATION OF THE PIPES AND THE INDOOR UNIT.

- To prevent the entry of foreign substances into the circuit and to ensure the essential resistance to the pressures involved, it is essential to use only a manifold with pressure gauges for R410A.
- Only a vacuum pump with a check valve should be used to prevent the oil contained in it from being drawn back into the refrigeration circuit when it stops.

- Use the intake pump that can suction up to 666.6 Pa (5 mm Hg).
- Fully close the gas side and liquid side service valves.

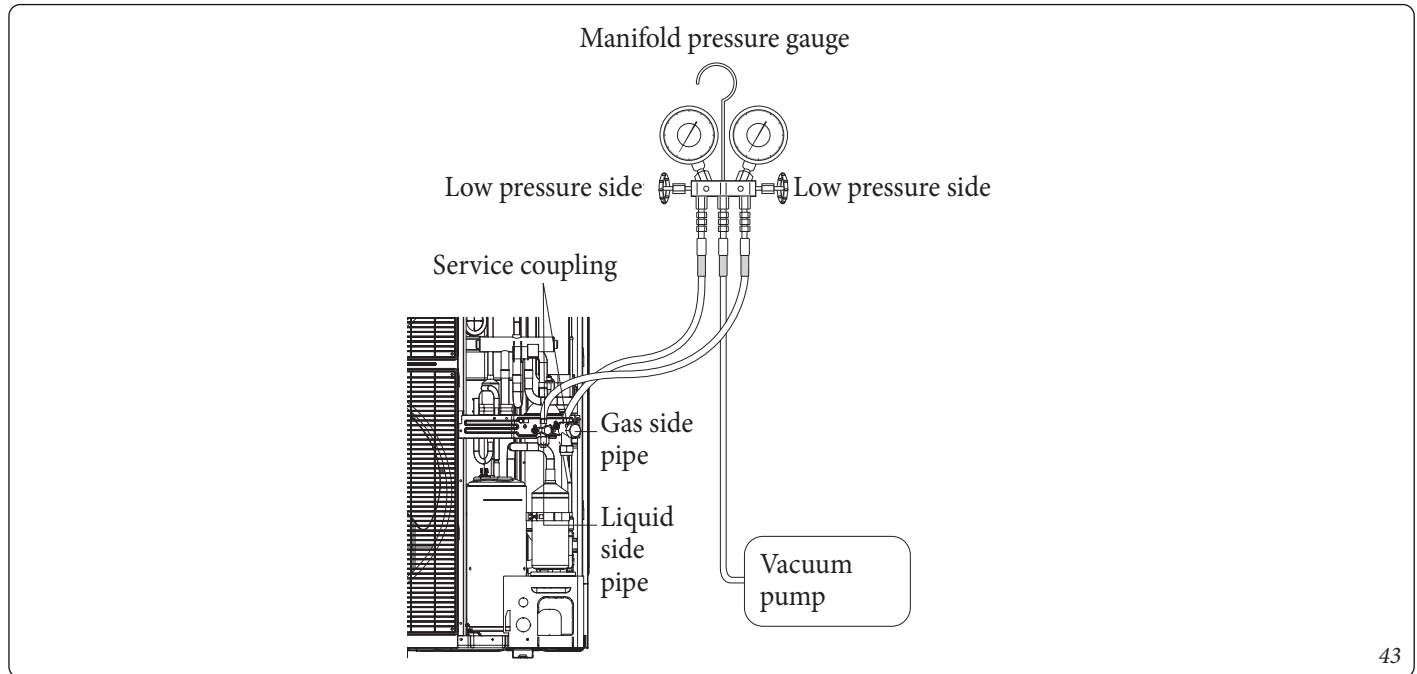

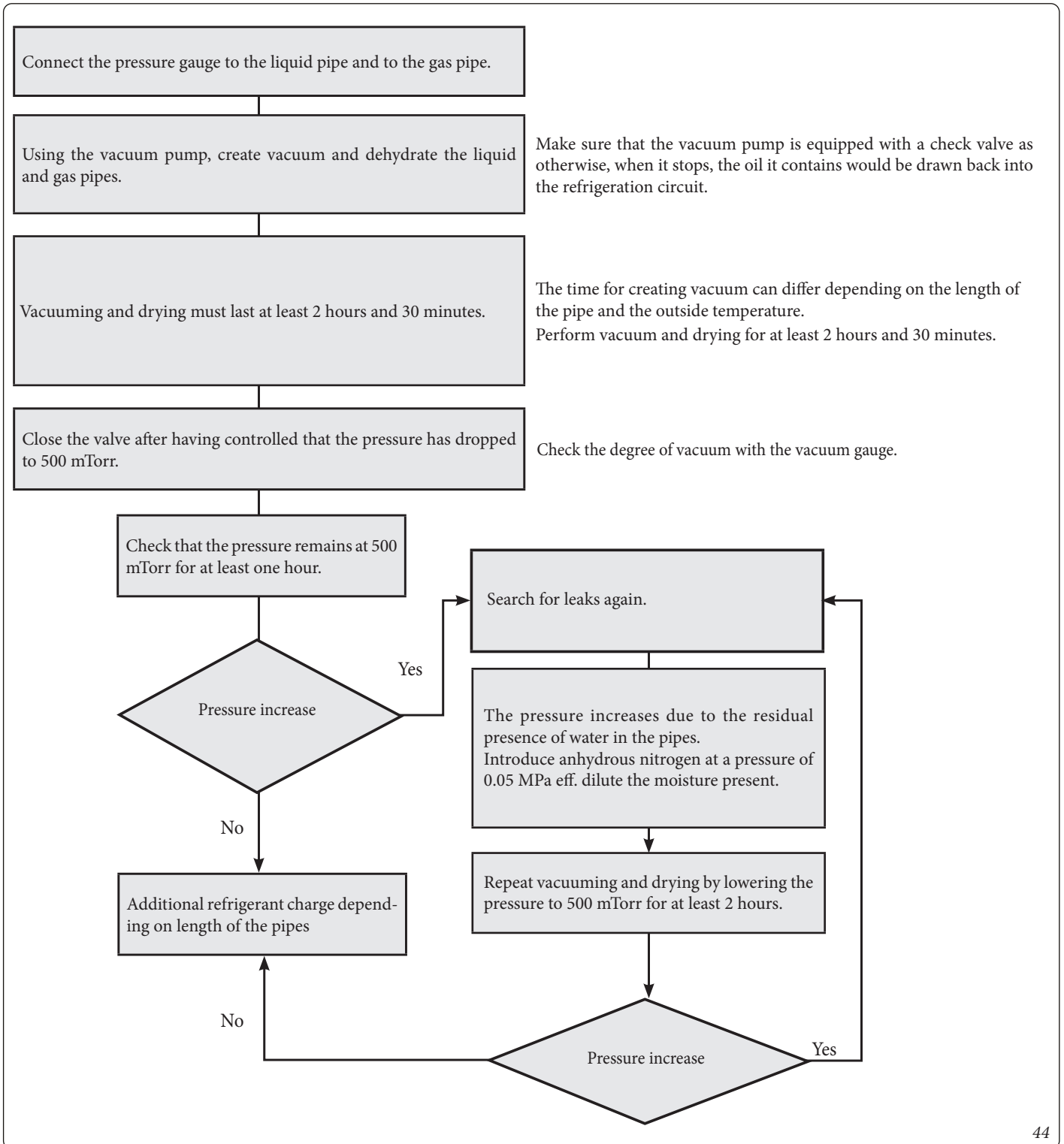

**ATTENTION:**

- If the pressure increases in an hour, moisture remains inside the tube, or there is a leak.



## 8.10 REFILLING THE REFRIGERANT CHARGE.

### Basic charge

The table below shows the amount of the basic charge introduced in the factory in the appliance:

Outdoor unit (model)	Basic charge (kg)
UE AUDAX PRO 12-14-16 V2	2.98
UE AUDAX PRO 12-14-16 V2 T	2.98

### Refilling depends on the total length and diameters of the pipes.

The basic charge refers to specified pipes having a maximum length of 15 m.

If the pipes used were longer, the charge should be topped up as described below.

### Adding the refrigerant.

The amount of topping up depends on the total length of the liquid pipes.

Outdoor unit of the liquid	Ø 9.52
Additional charge (g)	50 g/m

$$\text{Additional charge amount (G)} = (L2-15) \times 50$$

L2: Total length of pipes Ø 9.52 (m).



E.g.) Total length of the liquid pipe = 20 m

$$\Phi 9.52 = (20\text{m}-15\text{m}) \times 50\text{g/m} = 250 \text{ g}$$

## 8.11 REFILLING THE REFRIGERANT CHARGE.

- R410A is a mixture of several refrigerants. For this reason it must be introduced into the refrigeration circuit only in the liquid phase.

- The amount of refrigerant to be introduced depends on the lengths of the liquid pipes. It is advisable to use a scale to introduce the proper amount of refrigerant.

### Important information on standards relative to the refrigerant used.

This product contains fluorinated greenhouse gases. Do not release the gas into the atmosphere.

**- Inform the user if the system contains 5 tCO<sub>2</sub>e or more of fluorinated greenhouse gases. In this case, a leak test must be carried out once every 12 months, in compliance with regulation No. 517/2014. This job must be carried out by professionally qualified technical personnel only. In the situation considered above, the installer (or authorised person in charge of the final control) must draft a maintenance booklet containing all of the information prescribed in REGULATION (EU) No. 517/2014 OF THE EUROPEAN PARLIAMENT AND OF THE COUNCIL of 16 April 2014 on fluorinated greenhouse gases.**



The following data must be written in **indelible ink both on the plate supplied with the appliance and which relates to the refrigerant charge and in this manual (Fig. 45).**

- 1 = Refrigerant charge introduced into the appliance at the factory.
- 2 = Amount of additional refrigerant charged on-site.
- 1+2 = Total refrigerant recharge.

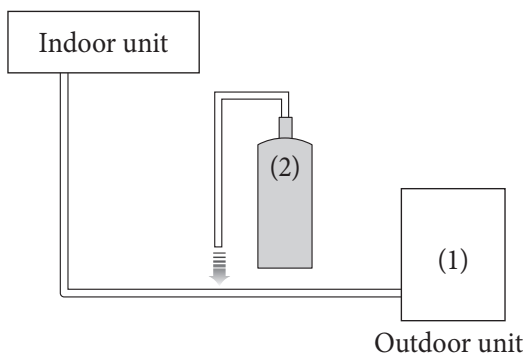

Type of refrigerant	GWP value
R-410A	2088

GWP: Global Warning Potential

Calculation of tons of CO<sub>2</sub> equivalent: kg x GWP/1000

- a. Charge product refrigerant in factory. See rating plate.
- b. Amount of additional refrigerant charged on-site. (Refer to the information below for the amount of refrigerant charge)
- c. Total refrigerant recharge.
- d. Refrigerant cylinder and charge manifold.



Unit	Kg	tCO <sub>2</sub> e
(1), a		
(2), b		
(1) + (2), c		

- Before charging, check whether or not the cylinder is siphoned and then position the cylinder accordingly (Fig. 46).

### 8.12 ADDING REFRIGERANT.

- R410A is a mixture of several refrigerants. For this reason it must be introduced into the refrigeration circuit only in the liquid phase.
- The amount of refrigerant to be introduced depends on the lengths of the liquid pipes. It is advisable to use a scale to introduce the proper amount of refrigerant.
- Connect the manifold to pressure gauges and bleed the air contained in it.
- Open the valve on the gas side of the manifold and introduce refrigerant in liquid phase.
- If it is not possible to completely recharge the additional refrigerant, while the unit is stopped, use the key on the PCB of the outdoor unit to recharge the remaining refrigerant.
- **Adding refrigerant in cooling.**
  1. Press the function key to add refrigerant in cooling mode.

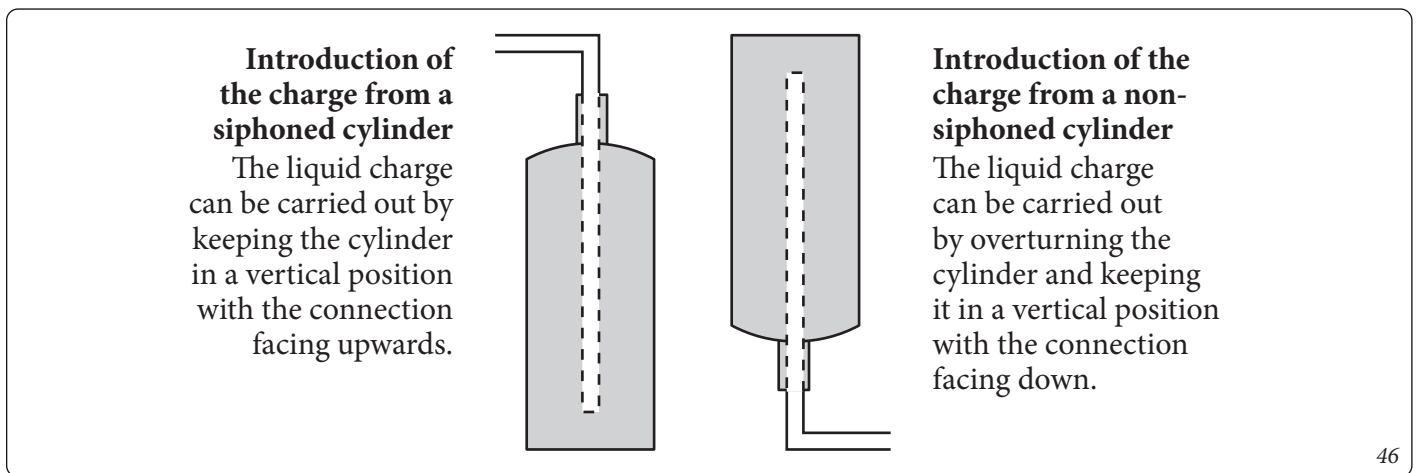

46

### Adding refrigerant in cooling.

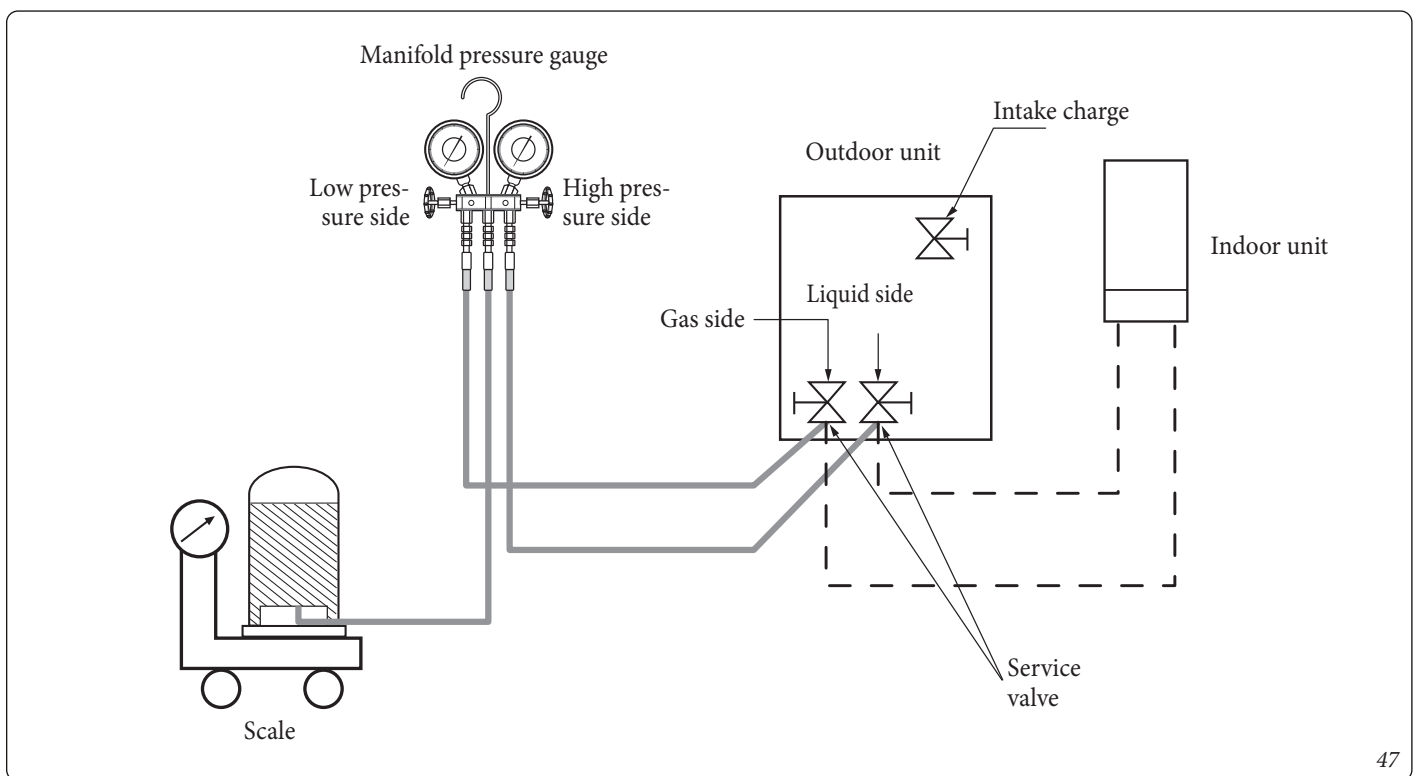

47

2. Open the valve on the gas side after 20 minutes of operation.
3. Open the valve on the low-pressure side of the manifold pressure gauge to recharge the remaining refrigerant.

- **Adding refrigerant in heating.**

1. Connect the low-pressure pipe from the manifold pressure gauge to the recharge intake door.
2. Press the function key to add refrigerant in heating mode.
3. Open the valve on the recharge intake door after 20 minutes of operation
4. Open the valve on the low-pressure side of the manifold pressure gauge to recharge the remaining refrigerant

**ATTENTION:**



- **Open the gas side and liquid side service valve completely after charging the refrigerant. (Operating the system with one of these valves not fully open could damage important components).**

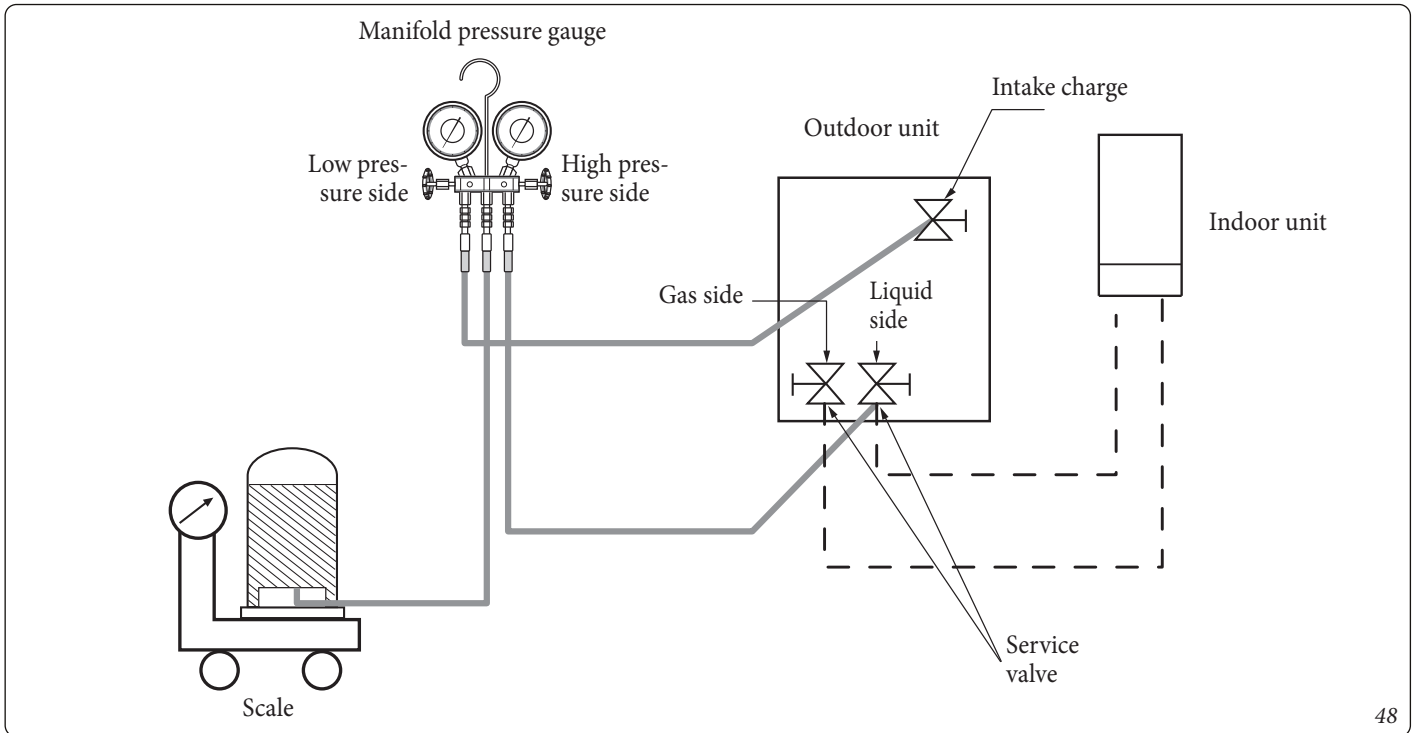

### 8.13 CLOSING THE VALVE STEM.

1. Open the cap and turn the valve stem clockwise using a hex wrench (Fig. 49).
2. Tighten the stem until it is completely closed.

- Do not force the stem and use only suitable tools. Otherwise, the sealing surface between the shutter and its seat could be damaged, resulting in refrigerant leaks.
- If refrigerant leaks are noticed, the valve should be opened slightly, closed again and make sure there are no more leaks. If so, the valve stem can be permanently tightened.



3. Refit and firmly tighten the valve cap.

### 8.14 OPENING THE VALVE STEM.

1. Remove the valve cap.
2. Turn the valve stem anticlockwise using a hex key.
3. Turn the valve stem until it stops.
4. Refit and firmly tighten the valve cap.

#### ATTENTION:



- When using the service coupling, always use a recharge pipe.
- Check for refrigerant leakage after tightening the cap.
- Use an open end spanner and an adjustable spanner when opening/tightening the valve stem.

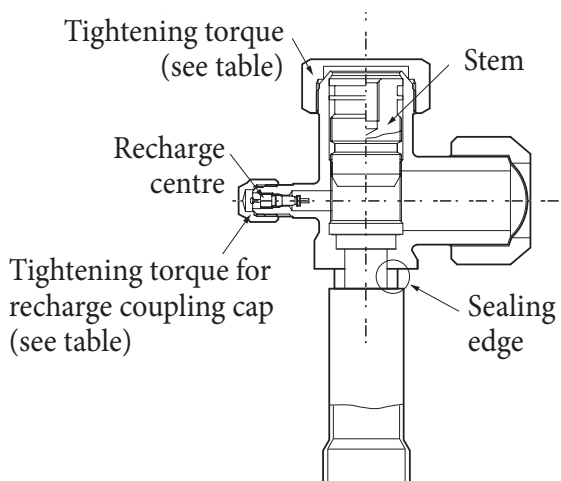

Outside diameter (mm)	Tightening torque (N·m)		Operating Torque (N·m)
	Body cap	Charging port cap	Stem
ø 9.52	20 ~ 25	10 ~ 12	Max 5
ø 15.88			Max 5

\* 1 N·m = 10 kgf·cm



# 9 COOLING CYCLE DIAGRAMS.

## 9.1 DIAGRAM.

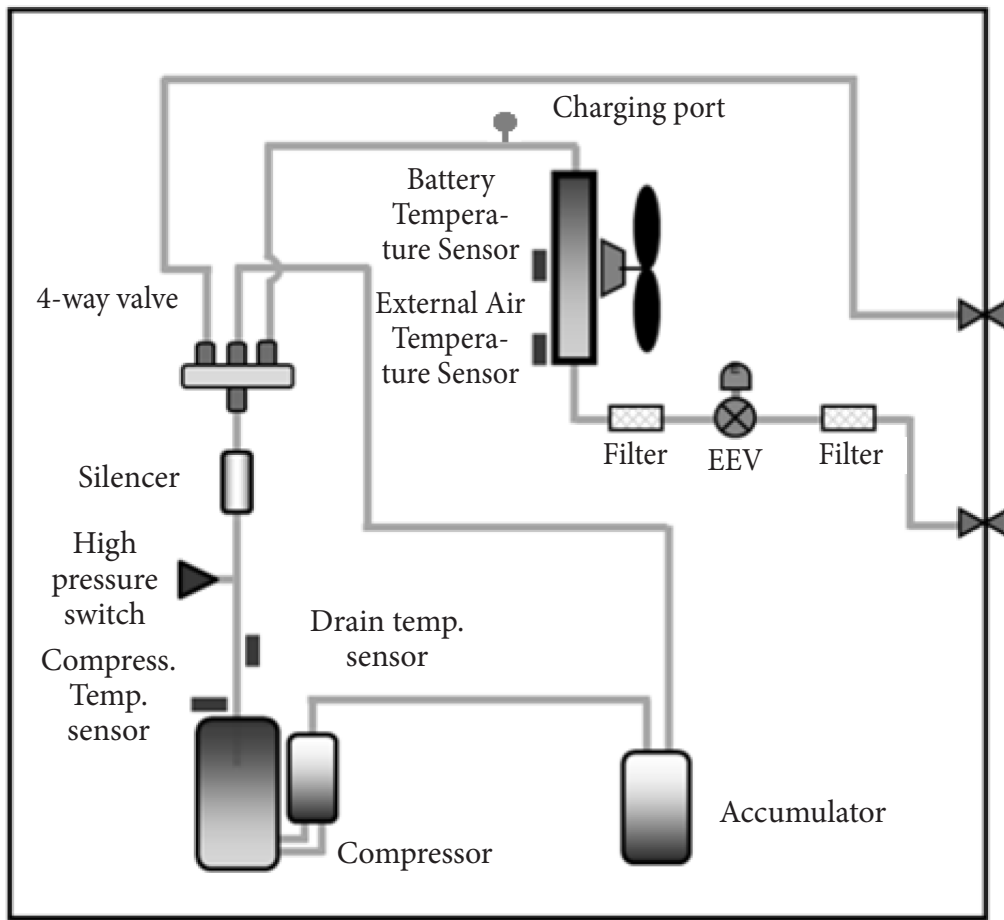

# 10 WIRING DIAGRAM.

## 10.1 SINGLE-PHASE WIRING DIAGRAM.

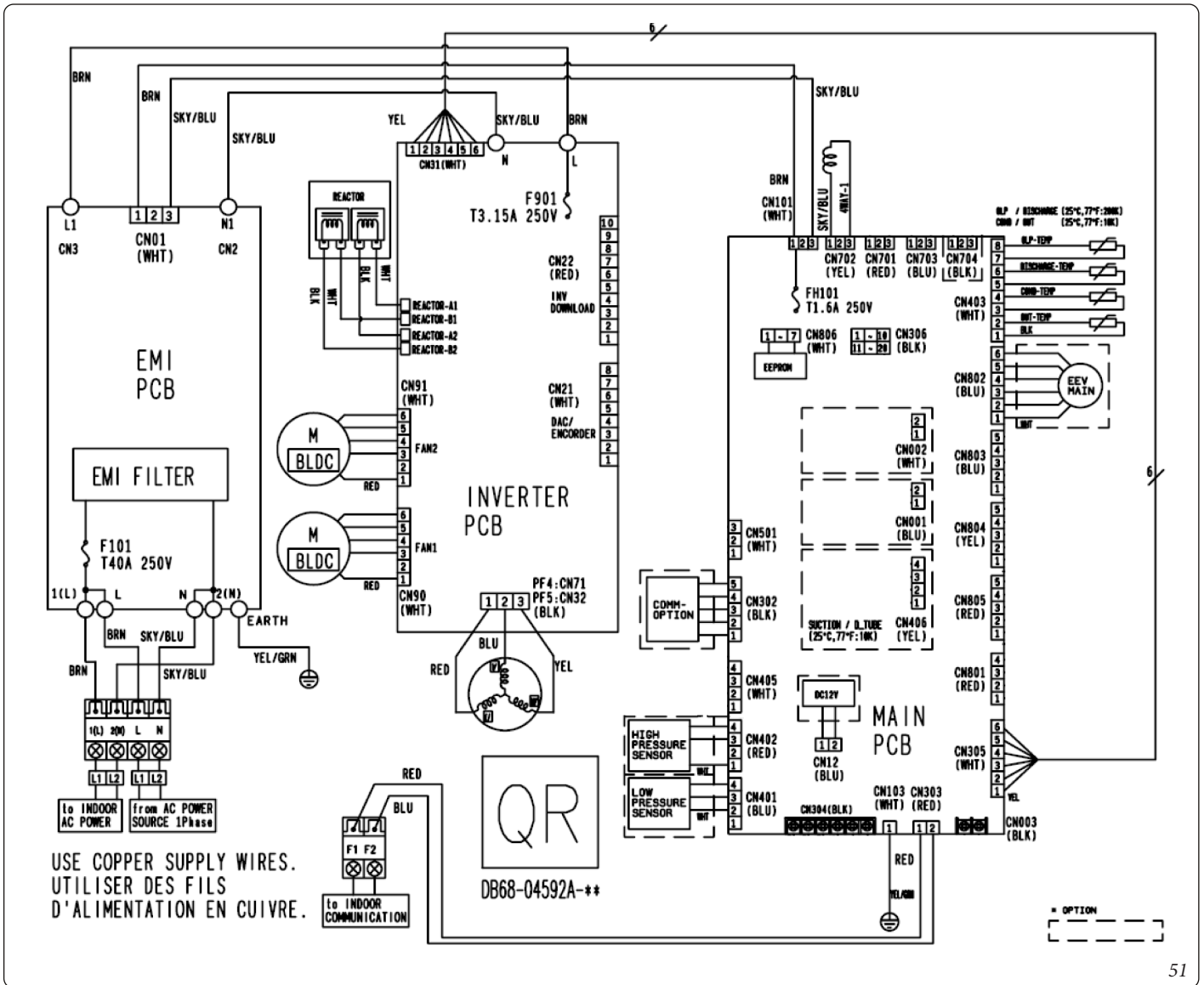

10.2 THREE-PHASE WIRING DIAGRAM.

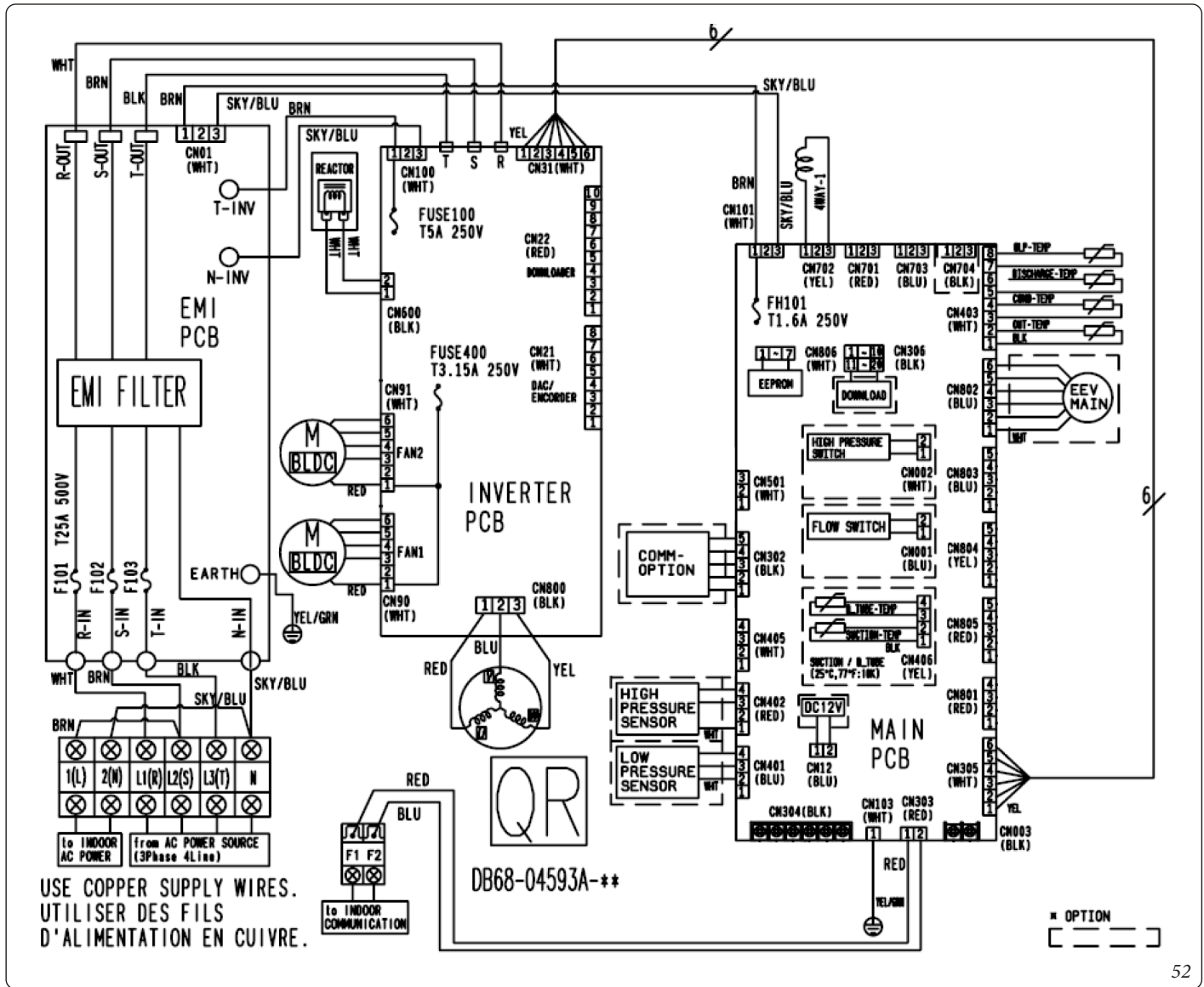

# 11 MICROWITCH AND KEY FUNCTION SETTINGS..

## 11.1 TESTING OPERATIONS.

1. Check the supply voltage between the outdoor unit and the circuit breaker.
  - Single-phase power supply: L, N
  - Three-phase power supply: R,S,T,N
2. Make sure the power cables are properly connected (otherwise the PCB may be seriously damaged).
3. Press K1 or K2 on the outdoor unit board to execute/interrupt testing operations

KEY	Operations on KEY	7-segment display
K1	Press once: Execution of heating test	"F" "F" "BLANK" "BLANK"
	Press twice: Execution of defrost test	"F" "3" "BLANK" "BLANK"
	Press 3 times: End of test mode	-
K2	Press once: Execution of cooling test (heating only: skip)	"F" "2" "BLANK" "BLANK"
	Press 2 times: Execution of outlet signal test	"F" "4" "BLANK" "BLANK"
	Press 3 times: End of test mode	-
K3	Reset	-
K4	View mode	Refer to display in view mode

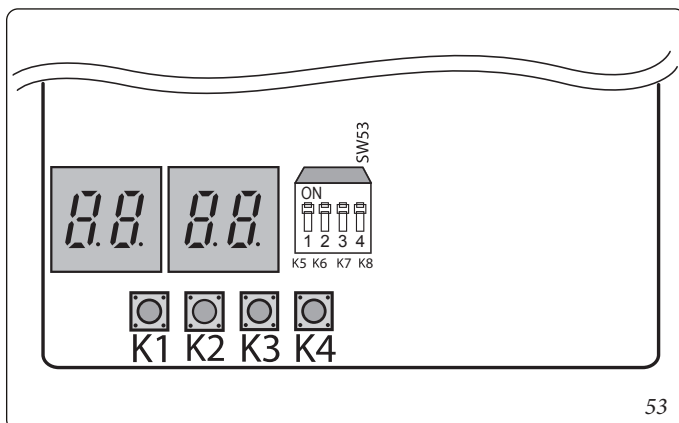
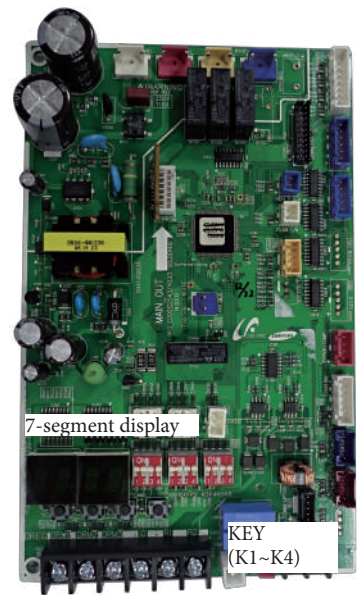

53

4. Display mode (Fig. 54): pressing K4, allows you to view information on the status of the system.

Number of times pressed	Contents viewed	Display				Unit
		Segment 1	Segment 2	Segment 3	Segment 4	
0	Communication status	10th digit of Tx	1st digit of Tx	10th digit of Rx	1st digit of Rx	-
1	Requested frequency	1	100th digit	10th digit	Unit	Hz
2	Current frequency	2	100th digit	10th digit	Unit	Hz
3	-	3	100th digit	10th digit	Unit	%
4	Outdoor air temp.	4	+/-	10th digit	Unit	°C
5	Compress. drain temp.	5	100th digit	10th digit	Unit	°C
6	Liquid phase sensor	6	+/-	10th digit	Unit	°C
7	Indoor unit return temp.	7	+/-	10th digit	Unit	°C
8	Indoor unit flow temp.	8	+/-	10th digit	Unit	°C
9	Battery temp.	9	+/-	10th digit	Unit	°C
10	Inverter current	A	10th digit	Unit	First decimal	A
11	Fan RPM	B	1000th digit	100th digit	10th digit	rpm
12	Drain temperature target	C	100th digit	10th digit	1st digit	°C
13	EEV	D	1000th digit	100th digit	10th digit	Passage
14	Protection control	E	0: Cooling 1: Central heating	Protection control 0: No protection control 1: Freezing 2: Defrosting 3: Overload 4: Supply 5: Total current	Frequency status 0: Normal 1: Maintained 2: Down 3: Upper limit 4: Lower limit	-
15	Inverter temperature	F	+/-	10th digit	Unit	°C
long-1	Main board version	Year (Decimal)	Month (Hexadecimal)	Day (Two digits)	Day (One digit)	-
long-1 and 1	Inverter board version	Year (Decimal)	Month (Hexadecimal)	Day (Two digits)	Day (One digit)	-
long-1 and 2	EPROM version	Year (Decimal)	Month (Hexadecimal)	Day (Two digits)	Day (One digit)	-

5. Setting of microswitches (Fig. 54).

Key	ON (default)	OFF	Notes	
K5	Outdoor unit	Heating only		
K6	Anti accumulation of snow in OFF	Anti accumulation of snow in NO		
K7	Silent mode		In Silent mode the output power may be lower than normal.	
	K7	K8		Mode
K8	ON	ON		Silent mode Passage 1
	ON	OFF		Silent mode Passage 2
	OFF	ON		Silent mode Passage 3
	OFF	OFF		Silent mode Passage 1

6. Setting of function buttons (Fig. 54).

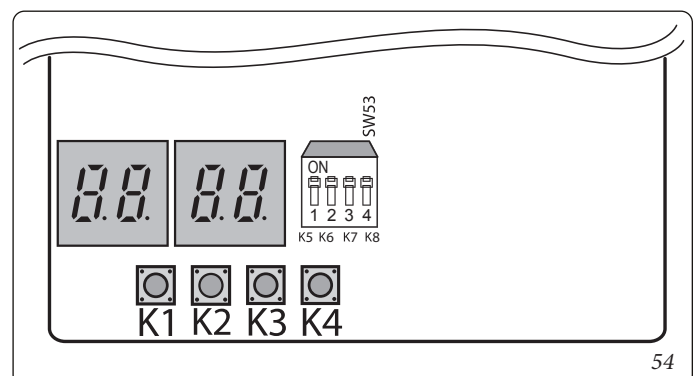

### Setting of the option.

1. Press and hold K2 to enter the option setting. (Only available when the operation is interrupted).

- If the option setting is entered, the display appears as follows.

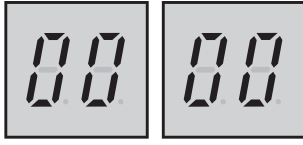

- Seg1 and Seg2 will show the number of the selected option.

- Seg3 and Seg4 will show the number of the set value of the selected option.

2. If the option setting has been entered, you may briefly press the switch K1 to adjust the value of Seg1, Seg2 and to select the desired option.

(Example):

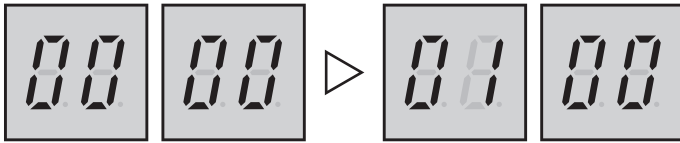

3. If you selected the desired option, you may briefly press the switch K2 to adjust the value of Seg3, Seg4 and to modify the function of the desired option.

(Example):

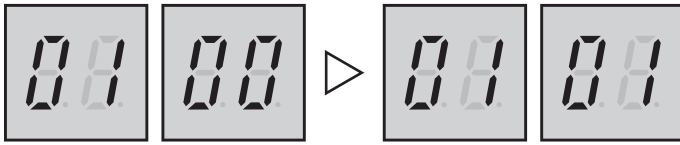

4. After having selected the function of the options, press and hold the switch K2 for 2 seconds. The modified value of the option will be saved when whole segments flash and mode monitoring begins.

### ATTENTION:



- **Option settings changes are not saved if the K2 button is not pressed for two seconds.**

- Holding down the K1 button restores the default settings before the modification.

- Restoring the factory settings is possible by keeping the K4 button pressed after putting the system in the function setting mode.

- Restoring the default settings does not involve their automatic saving. It is therefore necessary to keep button K2 pressed. By doing so, when the Segs flash to indicate the start of the search mode, the reset will be permanently saved.

# 12 “PUMP DOWN” EXECUTION.

## 12.1 PURPOSE OF “PUMP DOWN”.

The pump down is used to accumulate the refrigerant in the outdoor unit in the event of disconnecting the refrigeration lines for any reason.

## 12.2 IMPORTANT WARNINGS FOR “PUMP DOWN” EXECUTION.

- The slim design of the product limits the amount of refrigerant in the outdoor unit.
- Before carrying out the pump down, most of the charge can be transferred to an empty cylinder. The maximum amount of refrigerant is 5 kg.
- Accumulating larger quantities of refrigerant could cause compressor stoppages or burns.

1. Close the pressure gauge.
2. Close the liquid service valve.
3. Press the K2 button on the appliance board once and in doing so it switches to pump down mode.
4. Observe the low-pressure side using a pressure gauge unit while the compressor is running.
5. When the indication of this pressure gauge drops to less than 0 MPa (0 kgf/cm<sup>2</sup>) eff., close the gas service valve
6. Immediately afterwards, press the K3 button in order to stop the appliance.
7. Close the cap of both valves.

### ATTENTION:

- **If necessary, the refrigerant can also be transferred into suitable cylinders. If unsuitable cylinders are used, explosions could occur with consequent damage to things and injuries to people.**



### Repositioning the condensing unit.



- Proceed as follows if it is necessary to reposition the device.
- Perform the pump down procedure (implement the above procedure).
- Transfer as much refrigerant as possible into an external cylinder so as to be able to accumulate no more than 5 kg in the external unit (see page 36 for details on refrigerant charges)
- Unplug the power cable.
- Disconnect the connection cable between the indoor unit and the outdoor unit.
- Disconnect the pipes from the countersunk connections of the indoor unit.
- To prevent the entry of foreign material, immediately cover and seal the connections of the indoor unit and the pipes that were connected to it with caps or vinyl sheets.
- Disconnect the pipes from the countersunk connections of the outdoor unit. To prevent the entry of foreign material, immediately cover and seal the connections of the outdoor unit and the pipes that were connected to it with vinyl plugs.
- Be careful not to damage the connections and terminal blocks.
- Move the indoor and outdoor units to the new position.
- Disassemble the fixing devices of the indoor unit and reassemble them in the new position.

### 12.3 POURING THE REFRIGERANT INTO AN EXTERNAL CYLINDER BEFORE CARRYING OUT THE PUMP DOWN

If the amount of refrigerant in the outdoor unit exceeds the maximum allowed limit, follow the instructions below.

1. Get an empty cylinder for R410A, a scale and a manifold pressure gauge.
2. Check the amount of refrigerant in the refrigeration circuit.
3. Connect the cylinder to the outdoor unit and run about the 50% of the indoor units in cooling mode.
4. After 10 minutes check the pressure on the high-pressure side using the pressure gauge. If the pressure is higher than 3.0 MPa (30.59 kgf/cm<sup>2</sup>), reduce the quantity of indoor units in operation to drop the pressure below 3.0 MPa (30.59 kgf/cm<sup>2</sup>).
5. When the pressure drops below 3.0 MPa (30.59 kgf/cm<sup>2</sup>), open the valve of the pressure gauge (2) which is connected to the liquid side. Then open the valve of the receiving cylinder to allow the refrigerant to flow into it.
6. Check with the balance the quantity of refrigerant that has been transferred into the cylinder, close the liquid valve and disconnect the pressure gauge as soon as the desired quantity is reached.
7. The refrigerant quantity transferred should correspond to 50% of the entire charge contained in the refrigeration circuit.
8. The amount of charge left in the circuit must not exceed the amount that can be accumulated in the outdoor unit.

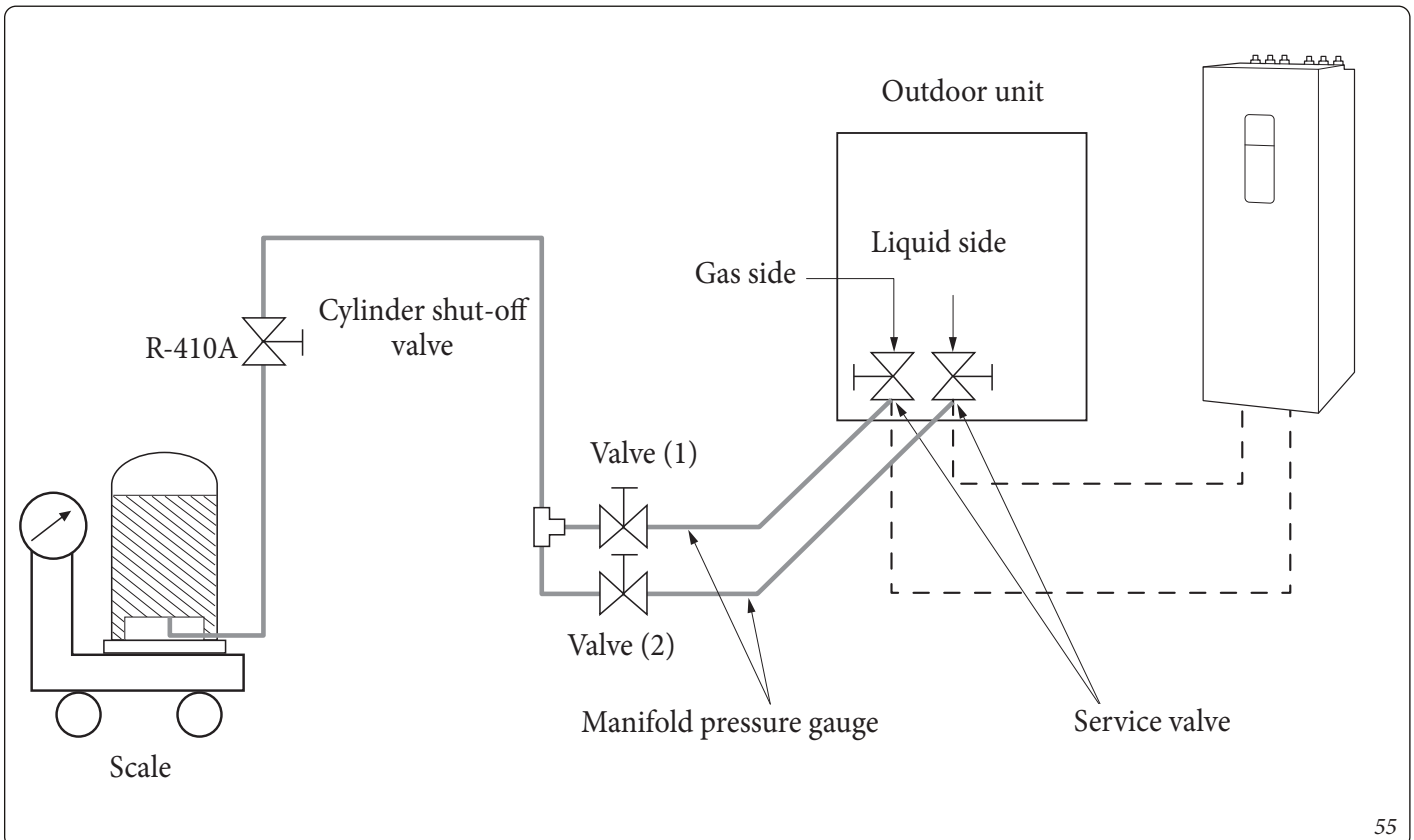



# 13 COMPLETION OF INSTALLATION.

- Check the following after having completed the installation.

Installation	Outdoor unit	<ul style="list-style-type: none"> <li>- Check the external surface and the inside of the outdoor unit.</li> <li>- Is a short-circuit possible?</li> <li>- Is the position well ventilated and is there clearance space for assistance?</li> <li>- Is the outdoor unit firmly fixed?</li> </ul>
	Indoor unit	<ul style="list-style-type: none"> <li>- Check the external surface and the inside of the indoor unit.</li> <li>- Is the position well ventilated and is there clearance space for assistance?</li> <li>- Check whether the centre of the indoor unit is fixed and if it is installed horizontally</li> </ul>
Adding refrigerant		<ul style="list-style-type: none"> <li>- Are the length and difference between the refrigerant pipes within the admissible range?</li> <li>- Is the pipe suitably insulated?</li> <li>- Has the amount of additional refrigerant been weighed correctly?</li> </ul>
Installation of drain pipe		<ul style="list-style-type: none"> <li>- Check the drain pipe of the outdoor unit and of the indoor unit.</li> <li>- Was the drain test completed?</li> <li>- Is the drain pipe suitably insulated?</li> </ul>
Perform the wiring		<ul style="list-style-type: none"> <li>- Was the outdoor unit earthed 3?</li> <li>- Is a 2-wire cable used?</li> <li>- Is the length of the wire within the limited range?</li> <li>- Is the wiring path correct?</li> </ul>

# 14 FINAL INSPECTIONS AND TEST OPERATION.

## 14.1 FINAL INSPECTIONS AND TEST OPERATION

1. Check the power cable and the communication cable of the indoor unit and outdoor unit.
2. Check the supply voltage between the outdoor unit and the electric panel.
  - Check the voltage at 220 V – 240 V~ / 380-415 V~ using a voltmeter.
3. Once the outdoor unit has been switched on, perform monitoring to verify that the indoor unit is connected and check the options.

## 14.2 TEST OPERATION.

1. **Activation of the device by means of the MODE button or the control system.**
  - Observe the behaviour of the compressor at start-up. Stop it if it makes a screeching noise.
2. **Check the operating status of the indoor and outdoor units.**
  - Check for any emission of abnormal noises from indoor units and/or the outdoor unit.
  - Make sure that condensation drains regularly in cooling mode.
3. **End of the test.**
4. **Explain to the customer how to use the condensing unit following the user manual.**

UE AUDAX PRO 12-14-16 V2 / UE AUDAX PRO 12-14-16 V2 T

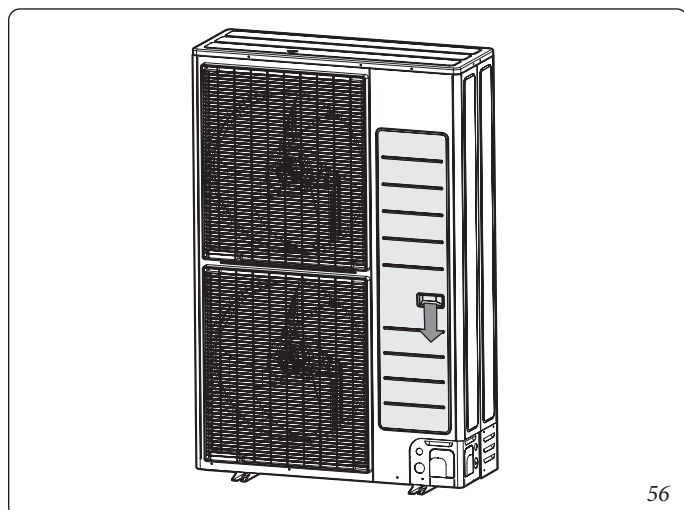

56





This instruction booklet  
is made of ecological paper



[immergas.com](http://immergas.com)

Immergas S.p.A.  
42041 Brescello (RE) - Italy  
Tel. 0522.689011  
Fax 0522.680617

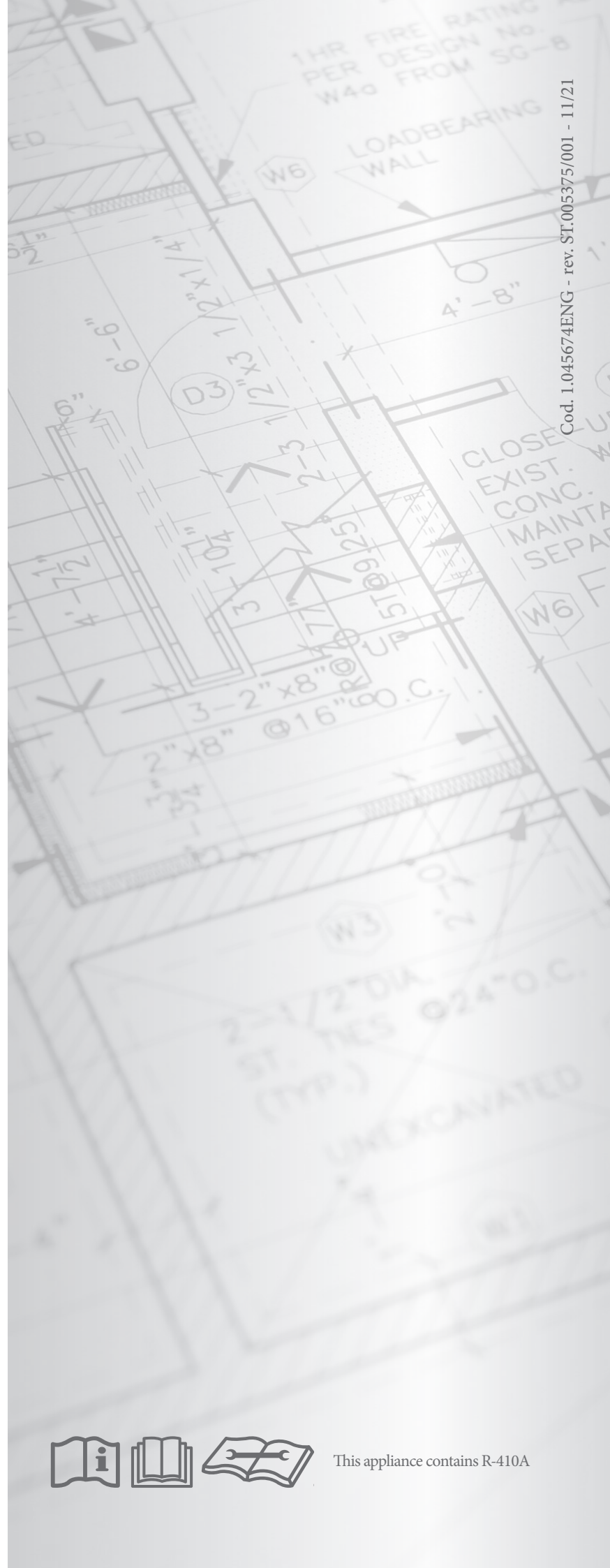

Cod. I.045674ENG - rev. ST.005375/001 - 11/21



This appliance contains R-410A