

CONDENSING

 **IMMERGAS**



# VICTRIX ZEUS SUPERIOR

Wall-hung condensing boiler  
with built-in stainless steel storage tank  
of 54 litres



# VICTRIX ZEUS SUPERIOR

Advanced performance and design, flexible installation

New design, hi-tech P.C.B., high hydraulic performances and excellent comfort in new homes and replacements, with a 54 liter storage tank. The new VICTRIX ZEUS SUPERIOR condensing boilers have 25, 30 and 35 kW heat output, very wide modulation ratio (from 10% to 100% of the heat power) to increase efficiency, low consumption pump and a condensation module with a coil characterized by increased passages to reduce the risk of clogging.

The VICTRIX ZEUS SUPERIOR **ecological class is 6**: the best one for keeping harmful emissions (CO and NO<sub>x</sub>) low. The **standard clapet** allows the **combination with multiple exhaust systems under positive pressure**. The last generation P.C.B. allows the **management of up to 3 zones from the dashboard** and of the controls with comfortable knobs as well as a wide display with backlit "touch" keys.

VICTRIX ZEUS SUPERIOR can be also installed outdoors in protected places and is supplied with a single product code because they work with methane, LPG or propane air. **The hydraulic connections are identical to the previous models** and the connection group is supplied as standard in order to support installers during replacement works.



94% seasonal efficiency

A+

VICTRIX ZEUS SUPERIOR can reach a higher energy classification (A+), if it is combined to an advanced Immergas thermoregulator such as **SMARTECH PLUS** or **CAR<sup>v2</sup>** (the latter connected to an external probe).



## SMARTECH PLUS.

### CONTROL THE BOILERS REMOTELY AND SAVE MONEY

The wireless hi-tech SMART chronothermostat with Bluetooth technology allows the adjustment of the heating temperature even with smartphones through a dedicated app.

The switch ON / OFF heating system can be based, through a special function, on **geolocation of family member**: the app raises the temperature when the occupant returns home and lowers it when the last one goes out. With the app **it is possible to manage up to 18 SMART thermostats** even in different homes.

SMARTECH PLUS is **easy to use** and to be read from every angle thanks to the e-ink technology used by the digital readers.

Some functions can also be supported by virtual assistants such as Alexa and Google Home.



*N.B.: for other optional kits that can be combined with SMARTECH PLUS see from page 12.*

## THE ADVANTAGES OF SMARTECH PLUS

- ▶ Modulating control of the heating in time slots with the display or remotely with the dedicated app (internet connection or Wi-Fi required)
- ▶ Switching on and off at time slots or with the geolocation of family member on the app
- ▶ Control of operation, consumption, modification of parameters and visualization of error codes on the website
- ▶ Very low consumption: it runs on batteries with autonomy of up to more than 2 years
- ▶ Easy to read thanks to e-ink display
- ▶ Control of up to 18 SMART thermostats in different houses, via app

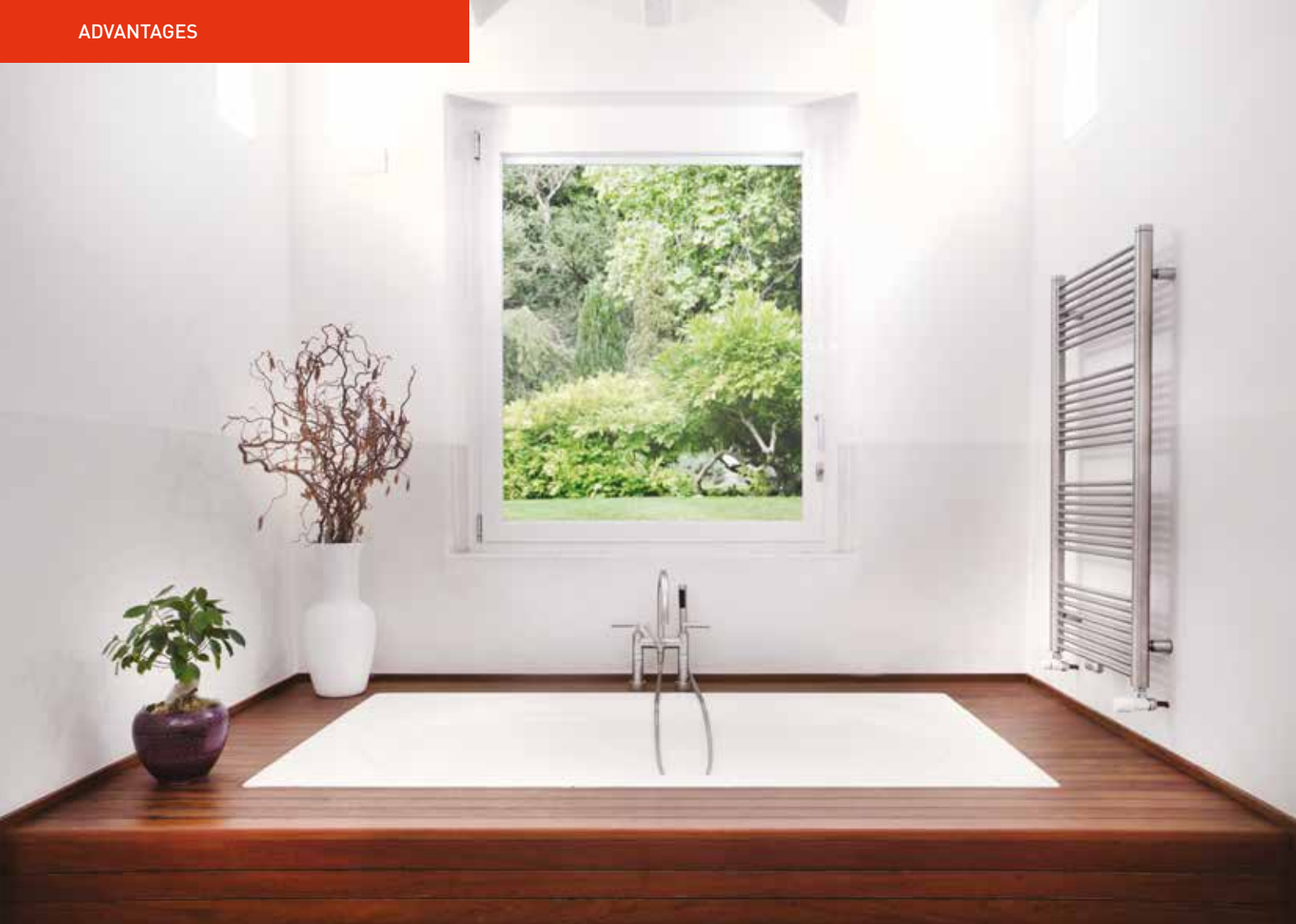

### **54 LITER STAINLESS STEEL BOILER**

The stainless steel guarantees the unchangeability of the storage tank towards the action of water while the wide flange optimizes the cleaning and maintenance operations. Inside the boiler is a stainless steel coil with double concentric spiral that ensures rapid heat exchange.

### **MULTIPLE DRAWINGS OF DOMESTIC HOT WATER**

The capacity of the stainless steel storage tank, combined with the excellent temperature regulation, allowed to obtain the \*\*\* marking according to EN 13203-1, i.e. the best D.H.W. performance, ensuring a high level of comfort even with simultaneous withdrawals of domestic hot water.

### **D.H.W. STORAGE TANK PROVIDED AS STANDARD**

### **APPROVED FOR OUTDOOR INSTALLATION**

Thanks to the new insulation that equips the stainless steel storage tank and to the standard protection up to 0 ° C, the VICTRIX ZEUS SUPERIOR boilers can be installed outdoors in a partially protected place. With addition to a suitable optional kit the protection can be extended up to -15 ° C (in presence of electricity and gas). The degree of electrical insulation is IPX5D.



### STAINLESS STEEL PRIMARY HEAT EXCHANGER

The primary heat exchanger supplied with VICTRIX ZEUS SUPERIOR is made with a stainless steel single-tube coil. In absence of manifolds and circuits installed in parallel it guarantees the **maximum reliability over time**: there are no welds.

The single stainless steel spiral without any constrictions allows a **perfectly balanced hydraulic circuit, considerably reducing head losses**.

The **internal section, constantly wide**, allows to limit deposits, reducing the risk of clogging in case of water impurities (for example in case of replacing boilers in outdated systems).

Due to this peculiarity, VICTRIX ZEUS SUPERIOR boilers are **ideal for replacement**.



### NEW AND ELEGANT DESIGN, HI-TECH ELECTRONICS

Equipped with **dashboard closing door and large display always visible, backlit touch keys and comfortable knobs for regulation.**

The display is well-lit and easily readable and the touch keys have **excellent touch feedback**, in line with the high quality level of the product.

In addition to the button illumination, the P.C.B. is equipped with an acoustic signal capable of highlighting with sounds controls implemented by the user on the buttons.

The **hi-tech electronics** provides numerous new functions such as the **possibility to manage 3 zones directly from the boiler control panel or the convenience of setting 4 comfort time bands and 4 calendars, for scheduling the operations both in the central heating and D.H.W. production.**

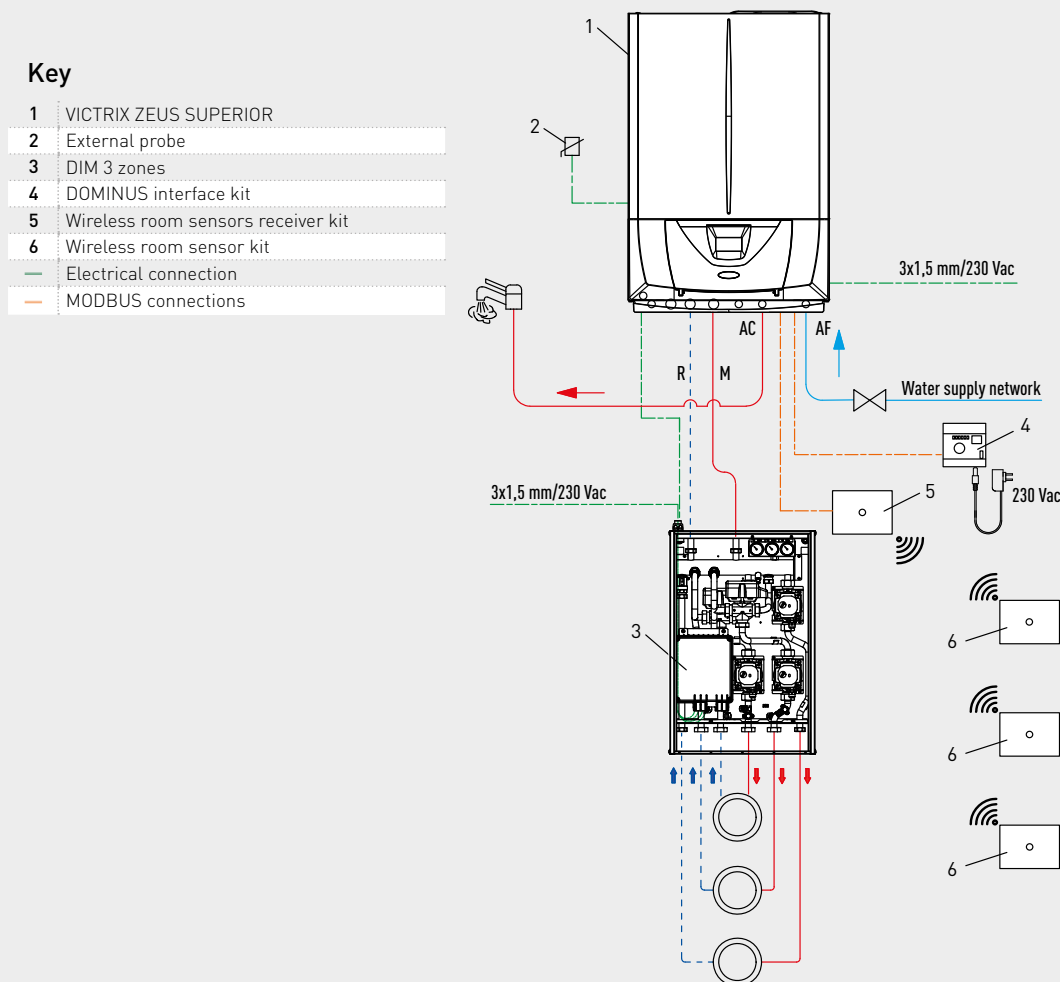

## THE EVOLUTION IN THERMOREGULATION

### Systems with multiple zones

Equipped as standard with last generation electronics, VICTRIX ZEUS SUPERIOR **can manage 3 zones with the help of wireless room sensor and concentrator** (both optional). The setting of room temperatures and time slot operating is made directly from the boiler dashboard or remotely via app (from phone, tablet or PC) with the help of the DOMINUS optional interface kit. It is also possible to interface with home automation management systems with KONNEX protocol (not supplied by Immergas). In particularly large single-family villas, the system can be managed by the multi-system distribution manifold (DIM ErP). The kit containing bottom guard is pre-arranged for fixing both the sensor concentrator and the DOMINUS interface card, making the operations of kit assembly easy.

### Single-zone systems

These applications can be easily managed through **SMARTTECH PLUS** (with appropriate remote control app), or with the **CAR<sup>V2</sup>** (both optional).

*Note: the optional kits described above are shown on page 12 of this catalogue.*





### FLUE SYSTEMS “GREEN SERIES”

The VICTRIX ZEUS SUPERIOR have a dedicated series of air intake / flue gas exhaust kits to ensure a high resistance to corrosion and a remarkable speed and functionality installation, also thanks to the coupling system and the material seals appropriate. VICTRIX ZEUS SUPERIOR boilers can be installed in sealed chamber configuration and forced draft or open chamber and forced draft (ideal for outdoor installation in place partially protected).

#### Open chamber, forced draft configuration

Type	Code
Flanged stub-pipe + bend + extension pipe Ø 80 0,5 m for flue discharge	3.016365
Cover kit	3.027446
Stainless steel vertical outlet kit Ø 80 (for external)*	3.024295

\* Combining with Ø 80 kit code 3.016364.

#### Sealed chamber, forced draft configuration

Twin pipe complete kit Ø 80/80 max length 36 m**	3.012002
Horizontal concentric complete kit Ø 60/100 max length 12,9 m**	3.012000
Horizontal concentric complete kit Ø 60/100 Ssort max length 11,9 m**	3.024598
Horizontal concentric complete kit Ø 60/100 with swivel terminal max length 9,9 m**	3.024267
Vertical concentric complete kit Ø 60/100 (red ocher colour)**	3.016833

\*\* For a correct calculation that takes into account curves and the insertion of special kits, refer to the boiler instruction booklet.





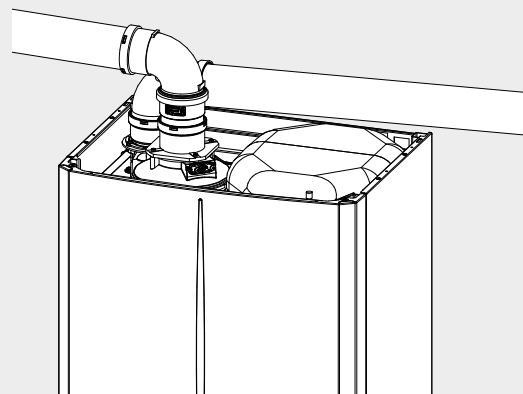
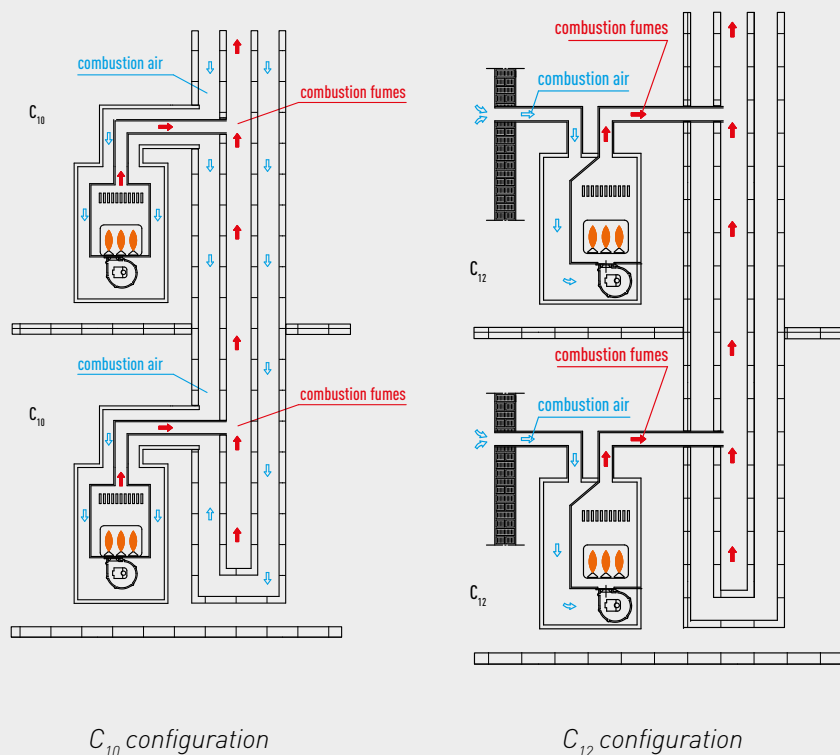

Detail of claret valve code 3.031599 with twin pipe Ø 80/80 configuration (C<sub>12</sub>)

### C<sub>10</sub> - C<sub>12</sub> CONFIGURATION

The EN 15502 Standard takes into consideration **the possibility that the main claret may over time lose its seal or be subject to malfunctions**, therefore it requires a “second safety”(code 3.031599, as option) for **boilers installed in living spaces, connected to collective flue systems operating under positive pressure.**

Furthermore during the boiler maintenance, the exhaust flue claret avoids the reflux of fumes into the environment in case of opening of the heat exchanger module, when other boilers are functioning and discharging in the same collective flue system.

#### Maximum allowed pipe length combining with collective flue systems operating under positive pressure:

- Flue systems Ø 80/125: 7,7 metres (C<sub>10</sub>)
- Flue systems Ø 80/80: 10 metres + 1 metre of intake terminal (C<sub>12</sub>)

*NOTE: the insertion of the claret valve code 3.031599 involves a variation in the flue distance between centers from the one shown in at page 13. For further information, see the instruction booklet supplied with the appliance.*



Technical characteristics	Unit of measurement	VICTRIX ZEUS SUPERIOR 25	VICTRIX ZEUS SUPERIOR 30	VICTRIX ZEUS SUPERIOR 35
<b>Code</b>		<b>3.030900</b>	<b>3.030901</b>	<b>3.030902</b>
<b>C.H. Energy class</b>		<b>A</b>	<b>A</b>	<b>A</b>
<b>D.H.W. Energy class/Stated load profile</b>		<b>A/XL</b>	<b>A/XL</b>	<b>A/XL</b>
Maximum nominal heat input (D.H.W. mode)	kW	25,9 [22.280]	30,9 [26.598]	34,8 [29.967]
Maximum nominal heat input (C.H. mode)	kW	20,8 [17.909]	29,0 [24.976]	29,0 [24.976]
Minimum nominal heat input (D.H.W. mode)	kW	4,9 [4.237]	7,2 [6.200]	7,2 [6.200]
Minimum nominal heat input (C.H. mode)	kW	2,5 [2.143]	3,0 [2.554]	3,0 [2.554]
Maximum nominal heat output (D.H.W. mode)	kW	25 [21.500]	30,0 [25.800]	33,8 [29.068]
Maximum nominal heat output (C.H. mode)	kW	20,2 [17.372]	28,2 [24.252]	28,2 [24.252]
Minimum nominal heat output (D.H.W. mode)	kW	4,7 [4.042]	7,0 [6.020]	7,0 [6.020]
Minimum nominal heat output (C.H. mode)	kW	2,3 [2.012]	2,8 [2.408]	2,8 [2.408]
Efficiency at nominal heat output (80/60°C)	%	97,0	97,1	97,1
Efficiency at 30% of load (80/60 °C)	%	102,3	102,5	102,5
Efficiency at nominal heat output (40/30°C)	%	107,1	106,8	106,8
Efficiency at 30% of load (40/30 °C)	%	109,9	109,7	109,7
Weighted CO/NO <sub>x</sub> with natural gas	mg/kWh	15/21	16/19	16/19
NO <sub>x</sub> class	-	6	6	6
Fan available head (Min. - Max.)	Pa	2 - 151	2 - 233	2 - 295
D.H.W. flow rate in the first 10 minutes $\Delta t$ 30 °C	l/min	15,1	16,7	19
D.H.W. flow rate for continuous service ( $\Delta t$ 30 °C)	l/min	12,4	15,0	16,9
Central heating expansion vessel nominal capacity (total)	litri	8 [5,8]	10 [7,1]	10 [7,1]
Electric protection index	IPX	5D	5D	5D
Full appliance weight (empty)	kg	119 [63,9]	121,9 [64,2]	121,9 [64,2]

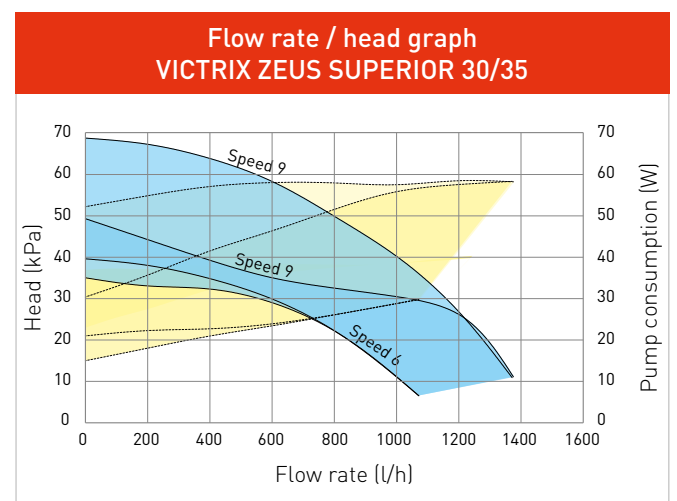
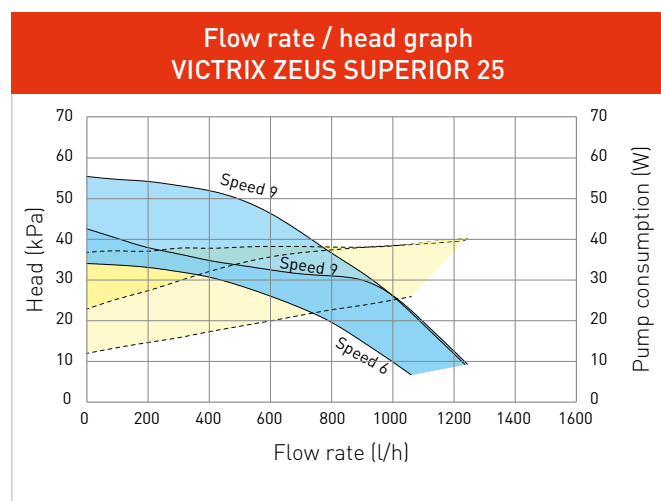

**Key**

- Available head for central heating with excluded by-pass
- Available head for central heating with inserted by-pass

- Pump consumption with excluded by-pass
- Pump consumption with inserted by-pass

VICTRIX ZEUS SUPERIOR are equipped with adjustable system by-pass.

VICTRIX ZEUS SUPERIOR 25/30/35

Key

V	Electrical connection
G	Gas supply
SC	Condensate drain (minimum internal diameter Ø 13 mm)
R	System return (optional)
M	System flow (optional)
RC	Ricircolo sanitario (optional)
AC	Domestic hot water outlet
AF	Domestic cold water inlet
A/S	Outlet/Inlet
A	Inlet
S	Outlet

VICTRIX ZEUS SUPERIOR hydraulic connections

Gas	D.H.W.		System	
G	AC	AF	R	M
1/2"	1/2"	1/2"	3/4"	3/4"

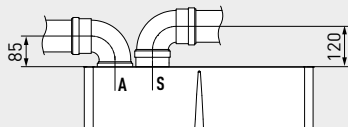
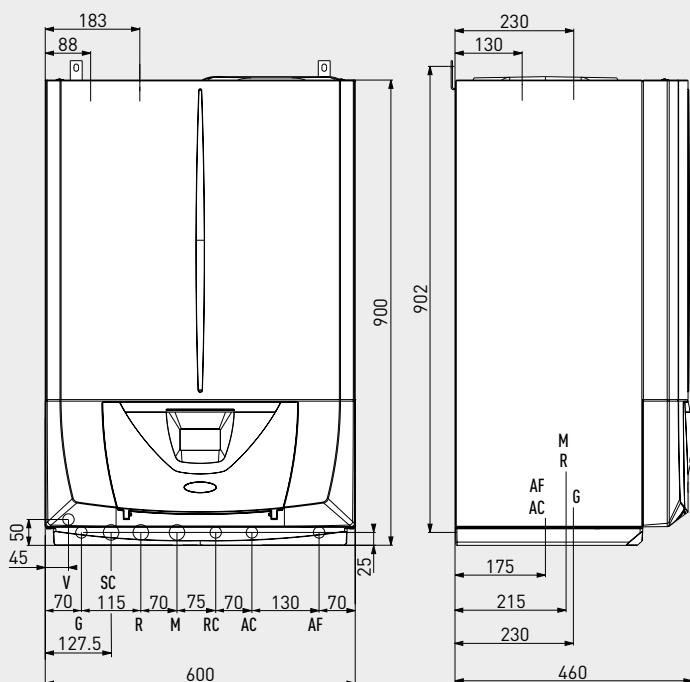

Twin pipe kit  
Ø 80/80

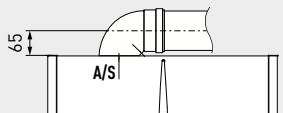

Horizontal kit  
Ø 60/100

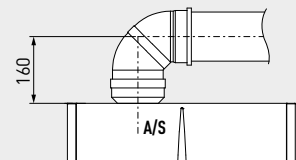

Horizontal kit  
Ø 80/125

NOTE: the insertion of the clapet valve code 3.031599 [see page 9] involves a variation in the flue distance between centers from the one shown in this drawing. For further information, see the instruction booklet supplied with the appliance.



To ensure correct installation of the appliance, the air inlet/flue outlet pipes kit must be selected from the Immergas "Green Series flue systems".



Combining VICTRIX ZEUS SUPERIOR with a climatic regulation device is an excellent investment because it improves the seasonal energy efficiency of the heating system. For each of the following thermoregulation devices we therefore indicate a class, which gives you the percentage value of increased efficiency.

**DOMINUS interface kit**

Type		Code
<p>Wi-fi interface kit to remote control by App.</p> <p>The Wi-Fi transmitter kit is to be interposed with a wireless modem / router (not supplied by Immergas) and must be installed outside the boiler.</p> <p>The kit allows you to manage 3 zones remotely. <b>NEW</b> Ideal for combining with wireless room probes cod. 3.030906.</p>		3.026273

**Wireless room sensor kit**

<p>Ideal for reading the room temperature. To create 3 zones is required to order 2 room probes (the third probe is present in the code 3.030908 to be ordered always together with this code). <b>NEW</b></p> <p>Product class: V* or VI Seasonal energy efficiency value 3%* or 4%</p> <p>Product class VIII using 3 wireless room sensor kits with modulating operative function Seasonal energy efficiency value 5%</p>		3.030906
---	--	----------

**Wireless room sensors receiver kit**

<p>To be positioned near the boiler or inside the bottom cover kit, similar in appearance to the wireless room sensor. N.B: this kit already includes 1 wireless room sensor <b>NEW</b></p>		3.030908
---	--	----------

**System delivery probe kit**

<p>To be positioned after the heating system manifold. <b>NEW</b></p>		3.030913
---	--	----------

**SMARTECH PLUS**

<p>Hi-tech smart wireless remote control with Bluetooth technology Equipped with:</p> <ul style="list-style-type: none"> <li>• gateway</li> <li>• wall fixing base (with integrated bubble level)</li> <li>• table stand</li> </ul> <p>Power supply 2 batteries (standard) Operating ambient temperature 0 - + 40 ° C Protection class IP 20</p> <p>Product class: V* or VI Seasonal energy efficiency value 3%* or 4%</p>	 <p>Dimensions (Ø x D) mm 70 x 35      Dimension (Ø x D) mm 70 x 18</p>	3.030909
--	---	----------

\* Product class with default settings. Some heat regulation device can change class depending on the settings and operation modes that can be changed, for example Modulating or ON/OFF, The use of these devices contributes, in percentage, to the seasonal energy efficiency of the heating system.

**CAR<sup>V2</sup> (modulating remote control)**

Type		Code
Modulating back-lighted chronothermostat and remote control. Special features including antifreeze temperature setting and antilegionella function (only for gas boilers with storage tank). <b>IDEAL FOR REPLACEMENT</b>		3.021395
Product class V* or VI Seasonal energy efficiency value 3%* or 4%	Dimensions (H x W x D) mm 103 x 142 x 31	

Available also in wireless version – code 3.021623.

**CRONO 7 (weekly digital chronothermostat)**

Weekly digital chronothermostat		3.021622
Product class IV* or VII Seasonal energy efficiency value 2% or 3,5%	Dimensions (H x W x D) mm 103 x 142 x 31	

Available also in wireless version – code 3.021624.

**External probe**

Allows at the boiler to functioning at a variable temperature according to the climatic conditions <b>IDEAL FOR REPLACEMENT</b>		3.014083
Product class II*, VI or VII Seasonal energy efficiency value 2%*, 4% or 3,5%		

**GSM Telephonic control**

For buildings not equipped with telephone network. Available for all models except MINI CRD		3.017182
	Dimensions (H x W x D) mm 198 x 78 x 30,5	

**Telephonic remote control**

For buildings equipped with telephone network. Available for all models except MINI CRD		3.013305
	Dimensions (H x W x D) mm 85 x 85 x 31	

**Relay board kit**

Allows interface between zone valves and CAR <sup>V2</sup> to send an alarm signal, to manage external pump etc.		3.015350
--	--	----------

**Low temperature safety thermostat kit**

For gas boilers set up with low temperature. (suitable only if using the specific connection kit)		3.019229
---	--	----------

\* Product class with default settings. Some heat regulation device can change class depending on the settings and operation modes that can be changed, for example Modulating or ON/OFF, The use of these devices contributes, in percentage, to the seasonal energy efficiency of the heating system.



Among the wide range of options it is possible to find out any specific accessories to complete the installation of VICTRIX ZEUS SUPERIOR. The use of original kits enhances quality and reliability of the products.

### Magnetic cyclone filter kit

Type		Code
To prevent system ferrous residual (only for internal installation). <i>IDEAL FOR REPLACEMENT</i>		3.024176

### Condensate discharge pump kit for wall-hung boilers

Usefull in case of counterslope between siphone and discharge; installation externaly to the boiler <i>IDEAL FOR REPLACEMENT</i>		3.026374
---	--	----------

### Condensate neutralizer kit

Necessary to neutralize the acidity of the condensation. Inclusive of granulate.		3.019857
---	--	----------

### Cover kit

For direct air suction <b>NEW</b>		3.030077
-----------------------------------	--	----------

### Bottom cover kit

Aesthetic frame (250 mm height 407 mm depth) that covers connections zone and the main option kits <i>IDEAL FOR REPLACEMENT</i> <b>NEW</b>		3.030438
---	--	----------

### Anti freeze protection kit -15 °C

Including electrical resistance for frost protection of the DHW circuit (in the presence of electricity). <b>NEW</b>		3.031804
--	--	----------

### Shut off knobs

Shut off knobs.		3.5324
Shut off knobs with filter.		3.015854

### Clock kit for recirculation

Type		Code
To be used to manage the recirculation pump.		3.015431

### Anti-scale kit

Approved for installation inside the building		3.013499
---	--	----------

### Recirculation kits (domestic hot water pump included)

The kit could be installed only inside the home.		3.015380
--	--	----------

### Recirculation kits (only probe pipe)

Kit to be added to an external circulator to the boiler.		3.012944
--	---	----------

*VICTRIX ZEUS SUPERIOR are designed to be combined to the DIM range, available for easy recessed installation (19 cm deep only) or wall-hung.*





[immergas.com](http://immergas.com)

Immergas S.p.A.  
42041 Brescello (RE) - Italy  
T. 0522.689011  
F. 0522.689178



**IMMERGAS**  
IMMERGAS SPA - ITALY  
CERTIFIED COMPANY  
UNI EN ISO 9001:2015

Design, manufacture and post-sale assistance of gas  
boilers, gas water heaters and related accessories